

# Beamever

## LINIO NEON 1615 TV PIXEL RGBW

IP67 protection with high performance silicone, UV resistant, solvents resistant. Seamless line in 30Mtrs roll.

One BIN Only to ensure perfect color consistency



Beamever

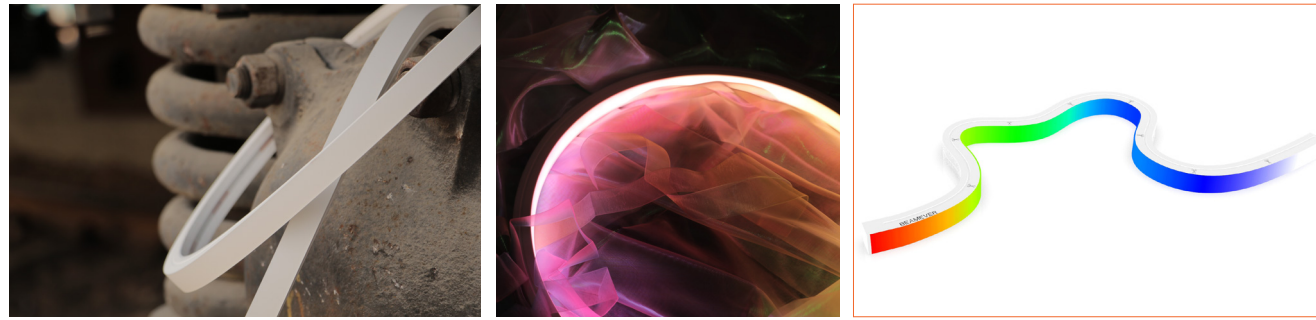

## LINIO NEON 1615 TV PIXEL RGBW

- Top view, Vertical bending with radius of 150mm / 5.9".
- DC24V, Cross section size 16mm x 15mm / 0.63" x 0.59" (W x H).
- IP67 protection with high performance silicone, UV resistant, solvents resistant.
- 30M/reel maximum. Max. Run length refers to single side feed in serial connection.
- Easy to be cut and reconnected at project sites. Custom length are available as well.
- Can be directly connected to any standard DMX controller, no need any decoders.

### Product Benefits:

- Homogeneous light effect & high light efficiency.
- Extremely durability and flexibility thanks to high performance materials.
- Not just good-looking but also weatherproof.

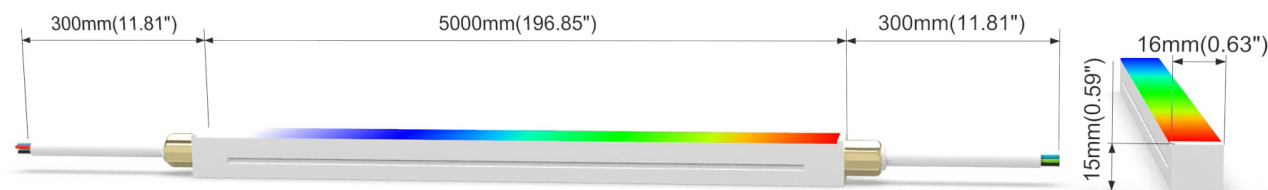
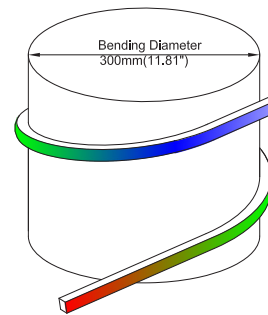

### Electrical data

Voltage	DC24V (23.5V <sub>min</sub> 24.5V <sub>max</sub> )
LED PIN Temperature	Max. 59.4°C / 138.92°F
Storage Temperature	-25°C / -13°F <sub>min</sub> 60°C / 140°F <sub>max</sub>
Ambient Temperature	T <sub>a</sub> min = -25°C / -13°F; T <sub>a</sub> max = 45°C / 113°F@15W T <sub>a</sub> max = 55°C / 131°F@3.5W(Single Color)
Power(W/m W/ft)	14/4.3
Gray Scale	256
Pixel/M	8
Control Mode	DMX 512

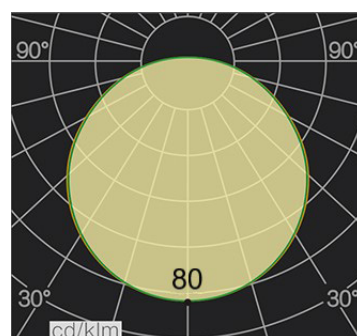

CCT	LM/Mtr	Max. Watt (W/M)	Max. Run Length (M)	Unit Cut (MM)
R	39	3.5	5	125
G	119	3.5	5	125
B	28	3.5	5	125
W27	200	3.5	5	125
W40	212	3.5	5	125
W53	203	3.5	5	125
RGBW40	398	14	5	125

### Important notice

- The given data are typical values due to the tolerances of the production process and the electrical components, values for light output and electrical power can vary up to 10%.
- The given color temperature is neon flex (after extrusion) color temperature.
- Standard cable length is 30cm, if longer cable required, please contact us.
- Male and female connectors are available if needed.
- It is IK08 rated. Please use protection materials if it is walk over application.



### Order code

SERIES NAME	COLOR	LENGTH	POWER	CABLE ENTRY
LNT PIXEL RGBW	27= 2700K 40= 4000K 53= 5300K	05000=5M/196.85"	014=14W	F=FRONT S=SIDE B=BOTTOM



**Front Cable Entry**  
Suitable for power feed in or straight connection. Do not bend down or aside too sharp.

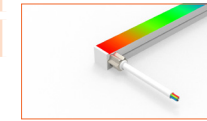

**Side Cable Entry**  
It can achieve perfect seamless light connection if the cabling space is allowed on the side.

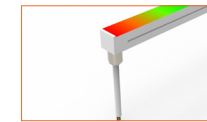

**Bottom Cable Entry**  
It can achieve perfect seamless light connection if the cabling space is allowed from the bottom.

Eg: LNT PIXEL RGBW40-02500-014-S: LINIO NEON 1615 TV PIXEL RGBW, W=4000K, 2.5M/reel, 14W/M, Side cable entry

### Accessories

Art.#	Description	Picture	Art.#	Description	Picture
SC001	1m anodized aluminium channel for LINIO NEON 1615 TV		MF021	Male and female connectors, 30cm IP67, 5PIN	
BC001	Clips 20mm 316L (Clip required every 25cm, stainless steel)		MF022	Extension connectors, 1m IP67, 5PIN	
M0002	Clips 20mm 316L (Clip required every 25cm, stainless steel)		MF023	Extension connectors, 5m IP67, 5PIN	
E0002	End cap with 30cm cable 5PIN for LINIO NEON 1615 TV PIXEL RGBW		K-1000C	SD Card program Controller DC5-24V, 2W output, 128MB-3GB capacity.	
E0003	Closed end cap for LINIO NEON 1615 TV PIXEL RGBW		SM-XMQ 1000A	Coder 9PCS built-in effects, only support DMX512 protocol chip.	
G0002	Silicone glue		T-780K	DMX Controller · DC5-24V, 8 channels, 5W output, Madrix system compatible.	

### Wiring connection

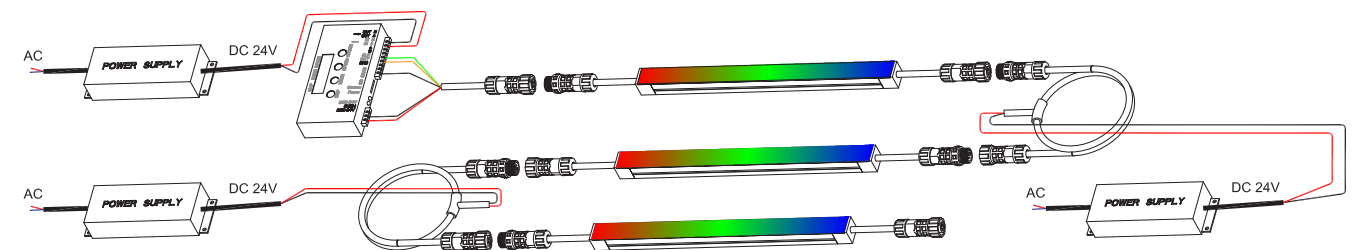

### Application

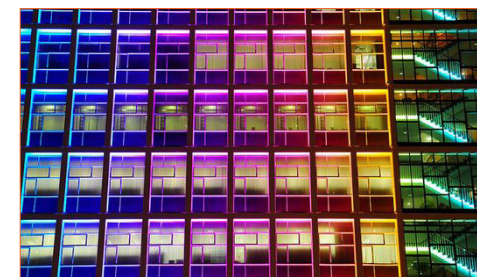

#### Where to use the product?

LINIO NEON 1615 TV PIXEL RGBW is pixel neon flex and each RGBW LED pixel (group of 10 LEDs) is individually addressable, so you can set the color for each one independent of every other pixel. You can create custom lighting animations and eye-catching dynamic lighting effects like chasing lighting effect, rain lighting effects.....with DMX controllers.

When it comes to video lighting effects and impressive dynamic lighting effects, our LINIO NEON 1615 TV PIXEL RGBW is perfect solution for you. It is a great choice for stage lighting, architectural lighting and decorative lighting.

# Beamever

**Front Cable Entry**  
Suitable for power feed in or straight connection. Do not bend down or aside too sharp.

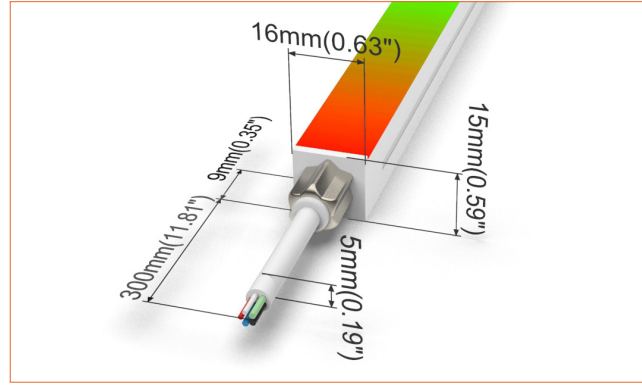
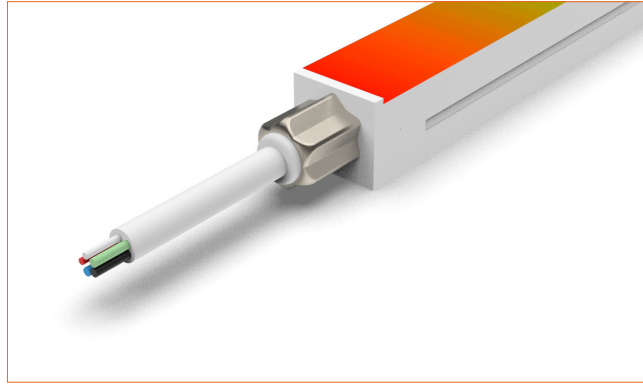

**Front double wire end:** 30cm cable from two ends, front cable entry.

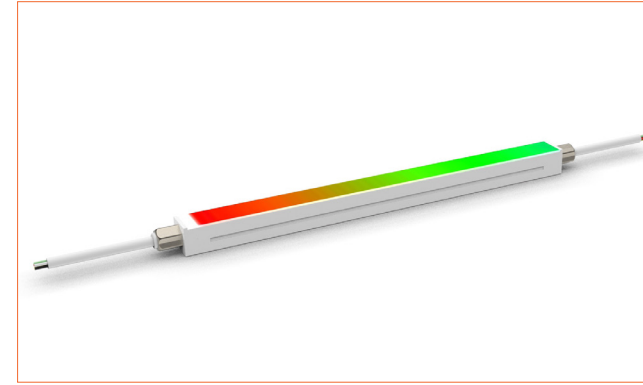

**Front single wire end:** 30cm cable from one end, front cable entry.

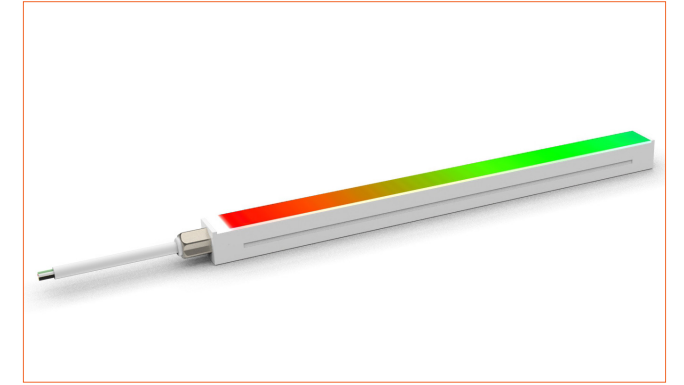

**Side Cable Entry**  
It can achieve perfect seamless light connection if the cabling space is allowed on the side.

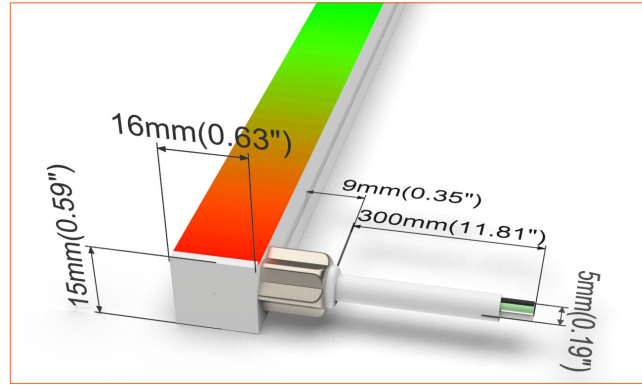
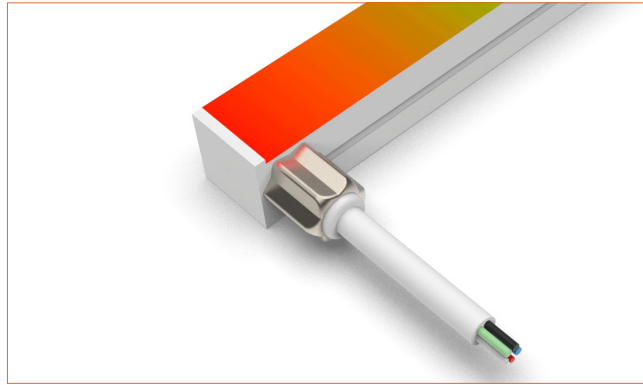

**Side double wire end:** 30cm cable from two ends, side cable entry.

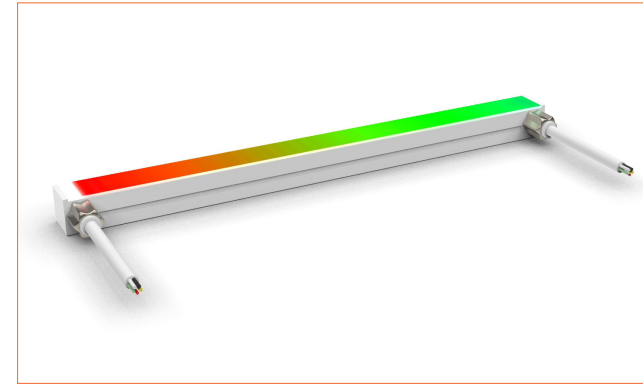

**Side single wire end:** 30cm cable from left one only (side cable entry), other end with closed end cap.

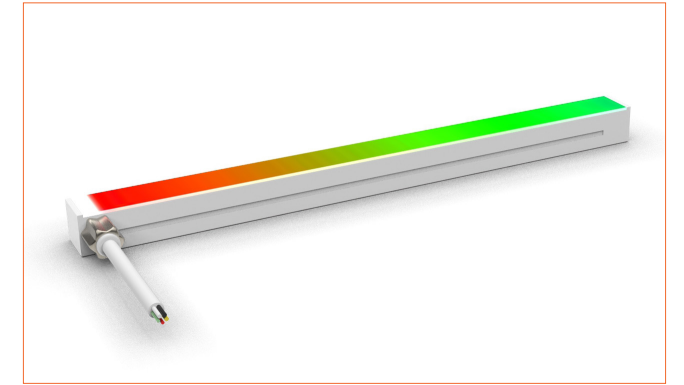

**Bottom Cable Entry**  
It can achieve perfect seamless light connection if the cabling space is allowed from the bottom.

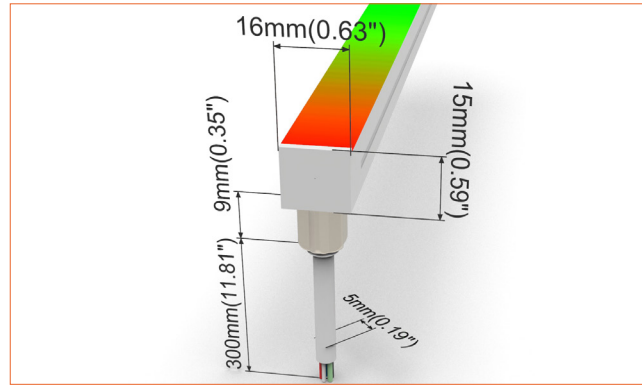
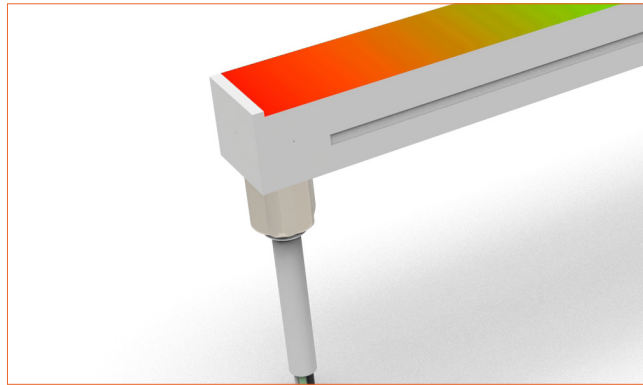

**Bottom double wire end:** 30cm cable from two ends, bottom cable entry.

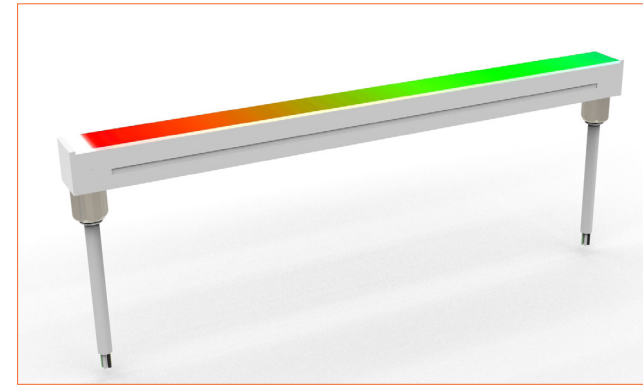

**Bottom single wire end:** 30cm cable from left one only (bottom cable entry), other end with closed end cap.

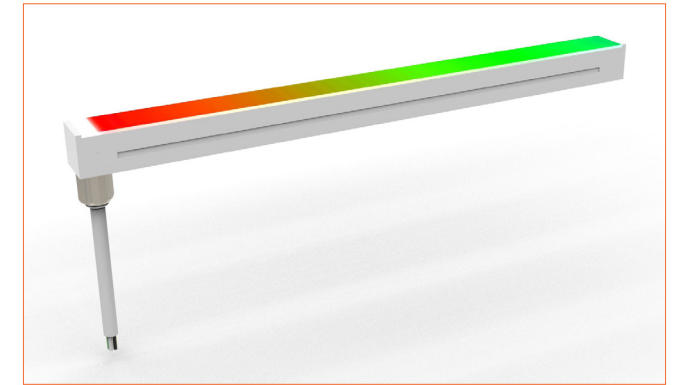

**Closed end cap**  
Elegant injecting closed end cap in same size as neon flex body.

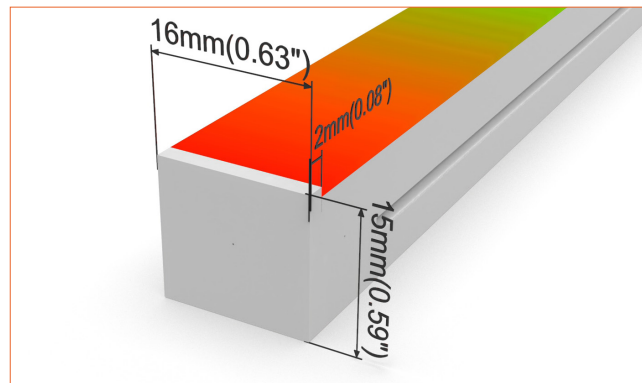
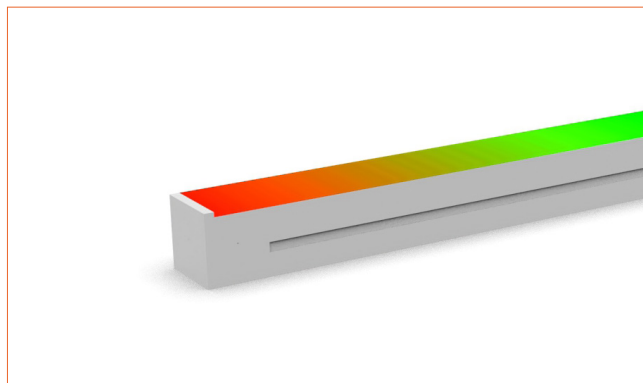



# Beamever

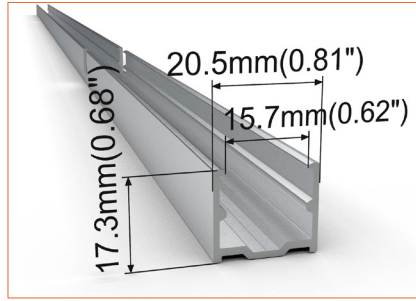
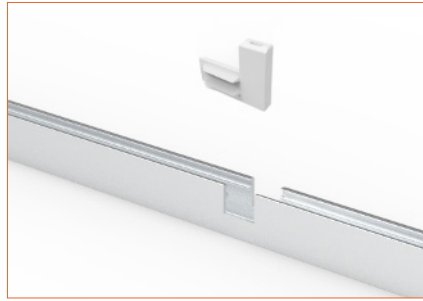

SC001  
Straight aluminium channel  
Length 1mtr

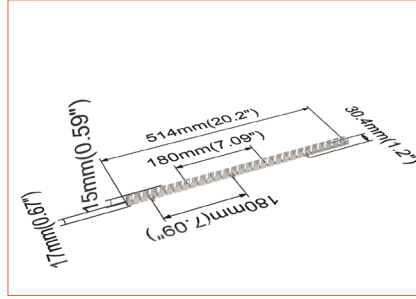
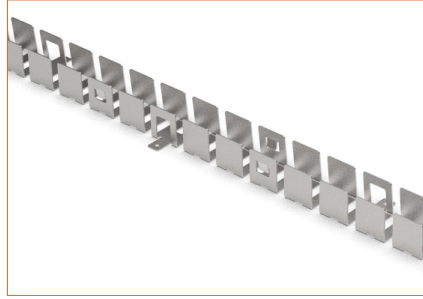

BC001  
Bendable stainless steel channel  
Length 0.5mtr

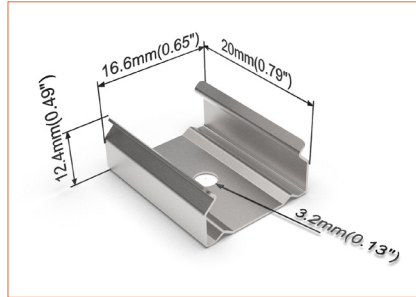
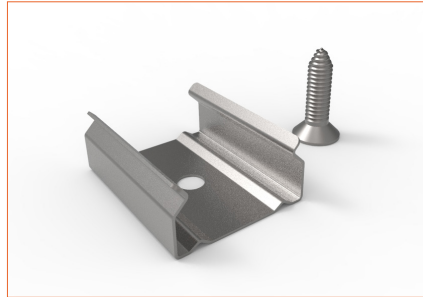

M0002  
Stainless steel mounting clip

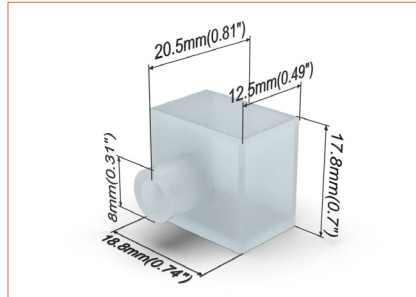
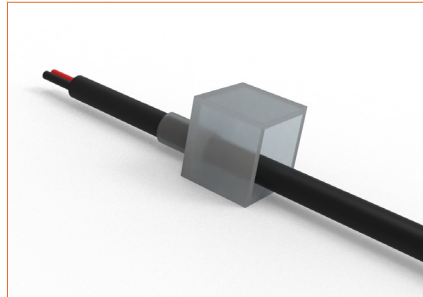

E0002  
End cap with 30cm cable

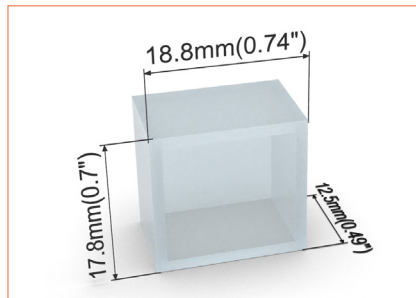
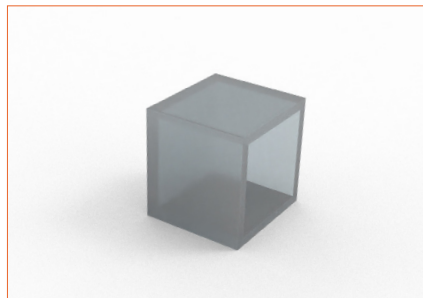

E0003  
Closed end cap



## Beamever

Address: 100 N Howard St Ste R,  
Spokane, WA, 99201-0508 USA  
Tel: 323-5104660  
info@beamever.com  
www.beamever.com