

NOVA TAPE SV

Indoor · White · Side-emitting

Beamever

Features

- Field cuttable & joinable
- Channel-free, easy to mount on smooth surface
- Slim and elegant, ideal for indoor applications
- 3M tape on the back makes it easy to install
- Slim side-emitting and dotless lighting
- 5 years warranty



Fixture type	
Project name	
Project phase	
Date	

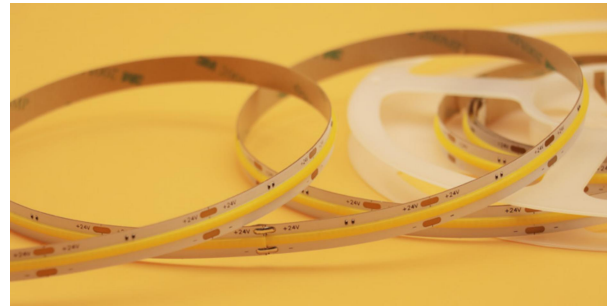

Dimension



Physical

PCB Width	8mm
LED Pitch	N/A
Cutting Interval	33.33mm
LED Brand	N/A
LED Size	COB
LED Quantity	480 LEDs/m
Housing Material	N/A
Housing Technique	N/A
Adhesive Type	Yellow 3M tape
Feed Entry	Front
Feed Length	Standard length 15cm
Storage Temperature	-20°C (-4°F) to 45°C (113°F)
Ambient Temperature	-20°C (-4°F) to 40°C (104°F)
Max Production Length	30m

Performance & Electrical

Voltage	24VDC (23.5Vmin, 24.5Vmax)
Beam Angle	180°
MacAdam	3 steps
Efficacy (lm/W)	60lm/W @4000K
CRI	Ra90
Lumen Maintenance	> 50,000 hours
IP Rating	IP20
Resistance	UV, solvent, saltwater, flame
Dimming	PWM, 0-10V, DMX
Control Protocol	N/A
Warranty	5 years

Certification & Safety

Certifications	UL, CE, RoHS, REACH, CB
Environment	Dry locations

Lumen/m	10W
■ 2400K	450
■ 2700K	500
■ 3000K	550
■ 4000K	600
■ 6500K	700
Max. Run Length(m)	5

NOVA TAPE SV

Indoor · White · Side-emitting



Order Code

Series	Temp./Color	Power	Connector Wire	IP Rating	Length(mm)
NOVASV	24=2400K 27=2700K 30=3000K 40=4000K 65=6500K	100=10W	OW=Open wire 15cm MFC=Male & female connector 20cm	20=IP20	Min. - 33.33mm Max. - 30000mm Cut Inc. - 33.33mm

Example: NOVASV-30-100-OW-20-05000

* Customizable—Contact Beamever representatives

Channels

Code	Description
BE1610	1m straight aluminium channel, surface mounting
BE2001	1m straight aluminium channel, recessed mounting
BE2004	1m straight aluminium channel, angled mounting
BE1604	1m straight aluminium channel, suspension mounting

* For more options, please refer to "Beamever Profile Spec Sheet"

Accessories (Optional)

Code	Description
MFC-2P-20	Male and female connector with 30cm cable, IP20, 2 pin
MFC-DC-44	Male and female DC connector with 30cm cable, IP44

* Please refer to "Accessories options" for more available models.

Power supplies

Code	Description
XLG-150-24-A	PSU 24V/150W IP67, Non dimmable, White
ELG-150-24B-3Y	PSU 24V/150W IP67, 3 in 1 dimming function
ELG-150-24DA-3Y	PSU 24V/150W IP67, DALI control technology

* Please refer to "Power supplies options" for more models available.

Note

* Leave your comments or other customized demands (if any) and contact Beamever.

NOVA TAPE SV

Indoor · White · Side-emitting



Mounting Options

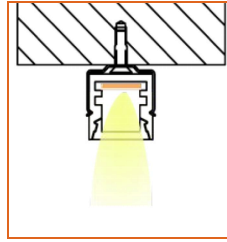
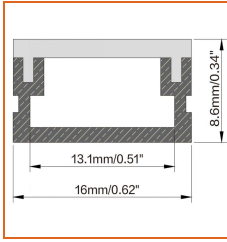
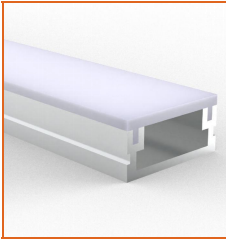

* Standard length is 1m/pcs.

Name Straight Aluminum channel

Code BE1610

Material Aluminum

Mounting style Surface mounted

Length 1m

Width 16mm

Height 8.6mm

Internal width 13.1mm

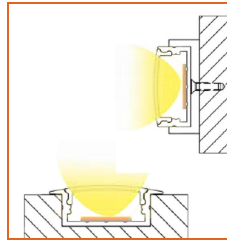
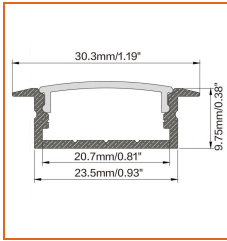
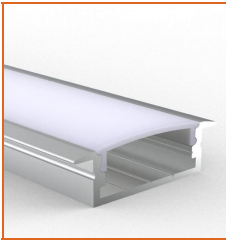

* Standard length is 1m/pcs.

Name Straight Aluminum channel

Code BE2001

Material Aluminum

Mounting style Recessed mounted

Length 1m

Width 30.3mm

Height 9.75mm

Internal width 20.7mm

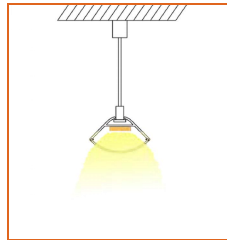
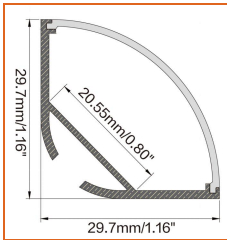
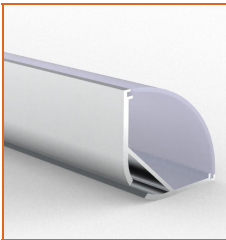

* Standard length is 1m/pcs.

Name Straight Aluminum channel

Code BE2004

Material Aluminum

Mounting style Angled mounted

Length 1m

Width 29.7mm

Height 29.7mm

Internal width 20.55mm

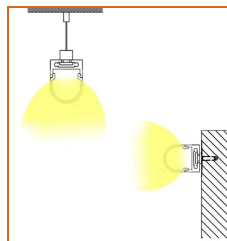
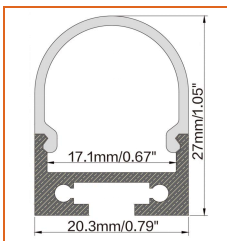

* Standard length is 1m/pcs.

* For more options, please refer to "Beamever Profile Spec Sheet"

Name Straight Aluminum channel

Code BE1604

Material Aluminum

Mounting style Suspension mounted

Length 1m

Width 20.3mm

Height 27mm

Internal width 17.1mm

NOVA TAPE SV

Indoor · White · Side-emitting



Power Supplies Options

Code	Max Load	Input	Output	Dimming	Environment	Size
XLG-150-24-A	150W	100-305VAC	24VDC	Non-Dim	Dry/Damp/IP67	180x63x35.5mm (L x W x H)
ELG-150-24B-3Y	150W	100-305VAC	24VDC	3 in 1 dimming	Dry/Damp/IP67	219x63x35.5mm (LxWxH)
ELG-150-24DA-3Y	150W	100-305VAC	24VDC	DALI control technology	Dry/Damp/IP67	219x63x35.5mm (L x W x H)
LPV-150-24	150W	180-305VAC	24VDC	Non-Dim	Dry/Damp/IP67	148x40x30mm (L x W x H)
LRS-150-24	150W	85-132V / 170-264VAC	24VDC	Non-Dim	Dry	99x97x30mm (L x W x H)
PWM-120-24	120W	90 ~ 305V / 127 ~ 431VAC	24VDC	3 in 1 dimming	Dry/Damp/IP67	191x63x37.5mm (LxWxH)

* Please refer to the spec sheet of each power supply for more detailed information

Accessories Options



Name Male & female connector

Code MFC-2P-20

Male and female connector with 30cm cable, IP20, 2 pin



Name Male & female DC connector

Code MFC-DC-44

Male and female DC connector with 30cm cable, IP44



Name VHB 3M adhesive tape

Code VHB-8

VHB 3M adhesive back tape, stronger stickiness.

Wiring Diagram

Non Dimmable

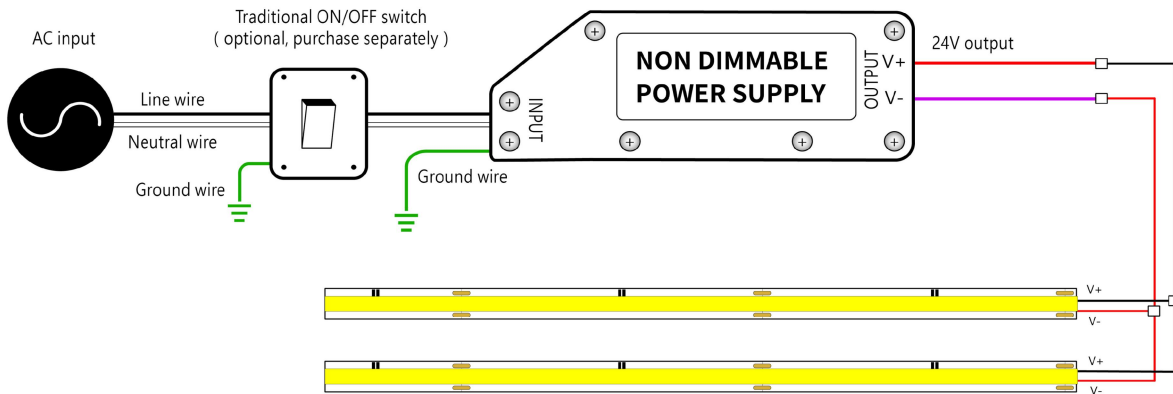

Dimmable

