

NOVA TAPE

Indoor · White · Dot-free

Beamever

Features

- Field cuttable & joinable
- Channel-free, easy to mount on smooth surface
- Slim and elegant, ideal for indoor applications
- 3M tape on the back makes it easy to install
- 5 years warranty
- Available in a variety of CCT color options



Fixture type	
Project name	
Project phase	
Date	



Dimension

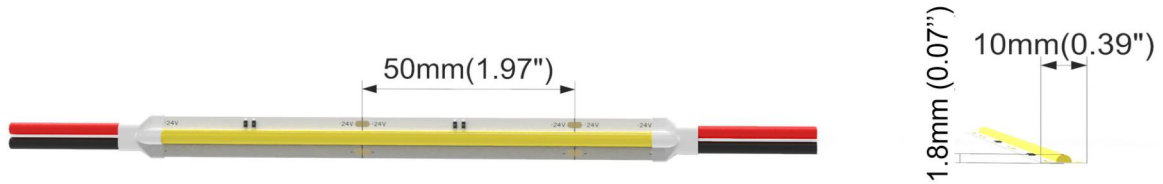

Physical

PCB Width	10mm
LED Pitch	N/A
Cutting Interval	50mm
LED Brand	Sanan
LED Type	COB
LED Quantity	480 LEDs/m
Housing Material	N/A
Housing Technique	N/A
Adhesive Type	Yellow 3M tape
Feed Entry	Front
Feed Length	Standard length 15cm
Storage Temperature	-25~60°C (-13~140°F)
Ambient Temperature	-20~45°C (-4~113°F)
Max Production Length	30m

Performance & Electrical

Voltage	24VDC (23.5Vmin, 24.5Vmax)
Beam Angle	150°
MacAdam	3 steps
Efficacy (lm/W)	110lm/W @4000K
CRI	Ra90
Lumen Maintenance	> 54,000 hours
IP Rating	IP20
Resistance	UV, solvent, saltwater, flame
Dimming	Triac, ELV, PWM, 0-10V, DMX, SPI
Control Protocol	N/A
Warranty	5 years

Certification & Safety

Certifications	UL, CE, RoHS, REACH, CB
Environment	Dry locations

Lumen/m	5W	10W	15W
■ 2700K	510	950	1380
■ 3000K	550	1000	1480
■ 4000K	627	1105	1600
■ 6500K	600	1100	1620
Max. Run Length (M)	8	6	5

*Other color temperatures and single chromatic colors customizable.

NOVA TAPE

Indoor · White · Dot-free



Order Code

Series	Temp./Color	Power	Feed Entry	Connector Wire	IP Rating	Length (mm)
NOVA	27=2700K 30=3000K 40=4000K 65=6500K	005=5W 010=10W 015=15W	FF=Front + Front FC=Front + Closed	OW=Open wire 15cm MFC=Male & female connector 20cm	20=IP20	Min. - 50mm Max. run - 8000mm@5W - 6000mm@10W - 5000mm@15W Cut Inc. - 50mm

Example: NOVA-30-005-FF-OW-20-05000

* Customizable—Contact Beamever representatives

Mounting Options

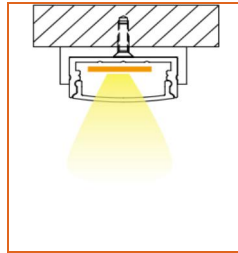
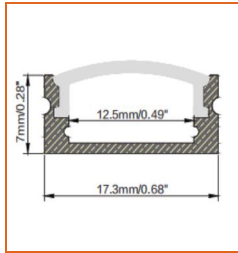
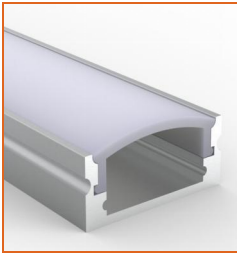

* Standard length is 1m/pcs.

Name	Straight aluminum channel
Code	BE1205
Material	Aluminum
Mounting style	Surface mounted
Length	1m
Width	17.3mm
Height	7mm
Internal width	12.5mm

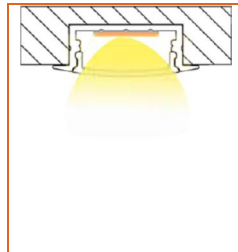
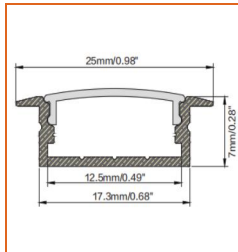
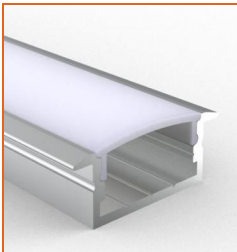

* Standard length is 1m/pcs.

Name	Straight aluminum channel
Code	BE1204
Material	Aluminum
Mounting style	Recessed mounted
Length	1m
Width	17.3mm
Height	7mm
Internal width	12.5mm

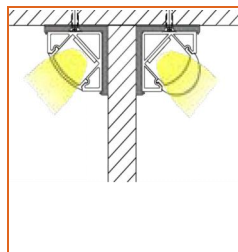
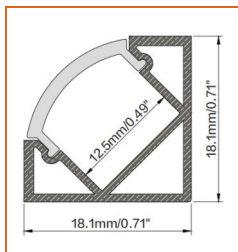
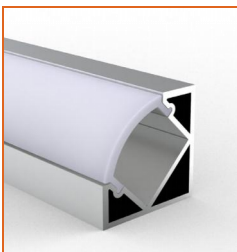

* Standard length is 1m/pcs.

Name	Straight aluminum channel
Code	BE1203
Material	Aluminum
Mounting style	Angled mounted
Length	1m
Width	18.1mm
Height	18.1mm
Internal width	12.5mm

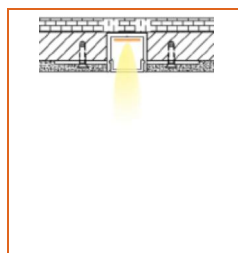
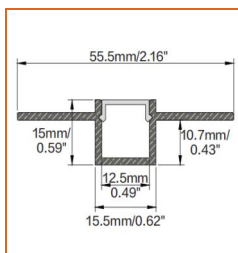
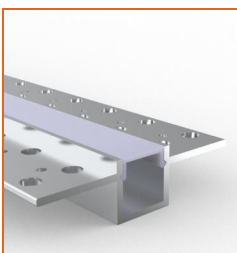

* Standard length is 1m/pcs.

* For more options, please refer to "Beamever Profile Spec Sheet"

Name	Straight aluminum channel
Code	BE5615
Material	Aluminum
Mounting style	Mud-in
Length	1m
Width	15.5mm
Height	15mm
Internal width	12.5mm

NOVA TAPE

Indoor · White · Dot-free



Driver Options

Code	Max Load	Input	Output	Dimming	Environment	Size
XLG-150-24-A	150W	100-305VAC	24VDC	Non-Dim	Dry/Damp/IP67	180x63x35.5mm (L x W x H)
ELG-150-24B-3Y	150W	100-305VAC	24VDC	3 in 1 dimming	Dry/Damp/IP67	219x63x35.5mm (LxWxH)
ELG-150-24DA-3Y	150W	100-305VAC	24VDC	DALI control technology	Dry/Damp/IP67	219x63x35.5mm (L x W x H)
LPV-150-24	150W	180-305VAC	24VDC	Non-Dim	Dry/Damp/IP67	148x40x30mm (L x W x H)
LRS-150-24	150W	85-132V / 170-264VAC	24VDC	Non-Dim	Dry	99x97x30mm (L x W x H)
PWM-120-24	120W	90 ~ 305V / 127 ~ 431VAC	24VDC	3 in 1 dimming	Dry/Damp/IP67	191x63x37.5mm (LxWxH)

* Please refer to the spec sheet of each power supply for more detailed information

Accessories Options (Optional)



Name Strip to strip connector

Code NOVA20-STS-2P-10

Strip to strip connector, 2 pin, IP20



Name Strip to strip jumper connector

Code NOVA20-STSJ-2P-10

Strip to strip jumper connector with 15cm cable, 2 pin, IP20



Name Strip to cable connector

Code NOVA20-STC-2P-10

Strip to cable connector with 15cm cable, 2 pin, IP20



Name L-shaped connector

Code NOVA20-L-2P-10

L-shaped connector, 2 pin, IP20



Name L-shaped corner connector

Code NOVA20-LC-2P-10

L-shaped corner connector, 2 pin, IP20



Name R-shaped corner connector

Code NOVA20-RC-2P-10

R-shaped corner connector, 2 pin, IP20



Name Male & female connector

Code MFC-2P-20

Male and female connector with 20cm cable, IP20, 2 pin



Name Male & female DC connector

Code MFC-DC-44

Male and female DC connector with 20cm cable, IP44



Name VHB 3M adhesive tape

Code VHB

VHB 3M adhesive back tape, stronger stickiness.

NOVA TAPE

Indoor · White · Dot-free

Beamever

Wiring Diagram

Non Dimmable

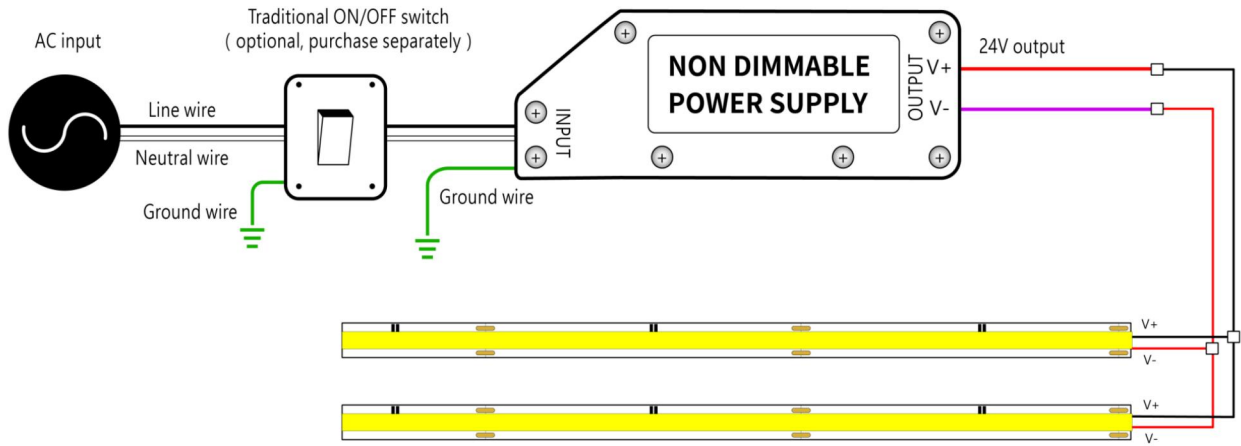

Dimmable

