

LINIO NEON 360° RGBW

Installation Instructions

Beamever

ATTENTION: This product should be installed by a professional licensed electrician.



Before you start

- 1 Verify all product is accounted for and in good condition. If not, skip installation instructions and see contact information at the bottom.
- 2 Please check local electrical codes.
- 3 Turn power off before installing, and make sure to use properly rated wire.
- 4 Modifying or not following instructions will void the warranty for this product.
- 5 Please read the instructions entirely before starting installation.
- 6 For specifications that call for more intricate installations, please don't hesitate to contact us at info@beamever.com.

Warning

- 1 Please operate this product by instructions, and confirm the work voltage, it must be matched with product requirements.
- 2 This product is not field cuttable. Any wrong operation will damage this product.
- 3 Use qualified DC power supply.
- 4 The most suitable operation temperature shall be -40~60°C (-40~140°F). DO NOT operate light when ambient temperature exceeds this range.
- 5 DO NOT energize the light over 30 minutes in coil packaging.
- 6 Please make sure the product does not stick with any paper related material directly.
- 7 The maximum bend diameter is 200mm. DO NOT overbend it which may cause product damage. Do not twist, drop, hang the product in any way other than intended. This product can bend vertically&horizontally in relation to its light output.

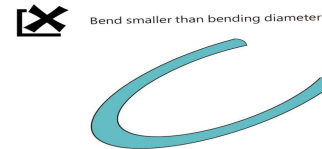
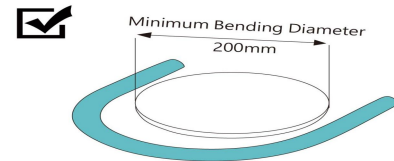
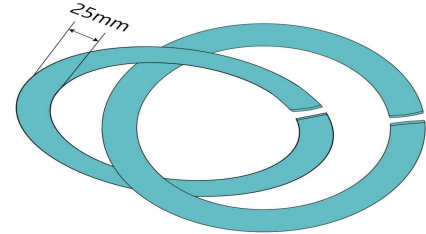

Installing Accessories

- Note**
- Disconnect power at the source prior to attempting installation.
 - NEVER wet the assembly units or assemble with wet hands.

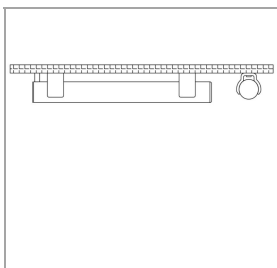

Surface mounting with open PC clips (LN360-01)

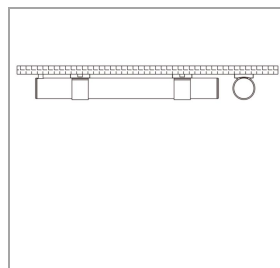

Surface mounting with closed clips (LN360-02)

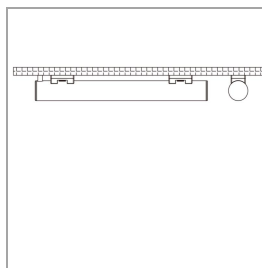

Surface mounting with clear low profile clip (LN360-03)

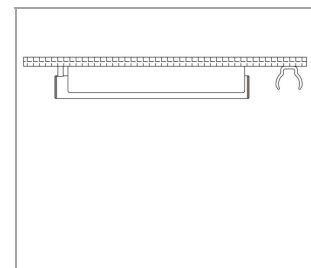

Surface mounting with PC profile (LN360-04)

LINIO NEON 360° RGBW

Installation Instructions

Beamever

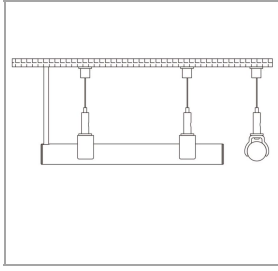

Suspended mounting with open PC clips (LN360-05)

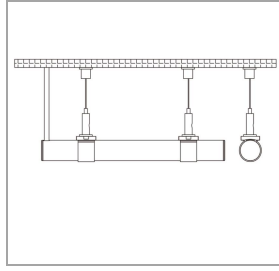

Suspended mounting with clear closed clip (LN360-06)

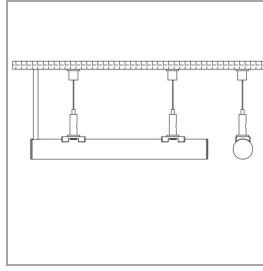

Suspended mounting with clear thin clip (LN360-07)

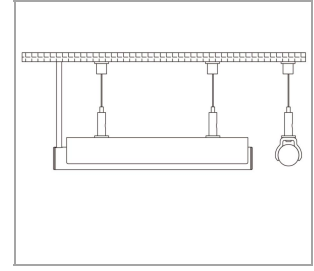

Horizontal suspended mount with PC profile (LN360-08)

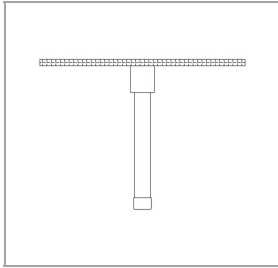

Vertical metal flush mounting (LN360-09)

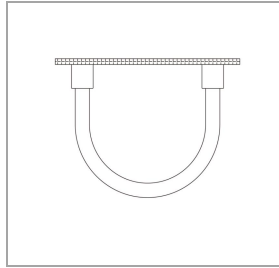

Metal flush mounting for "U" shape (ALN360-10)

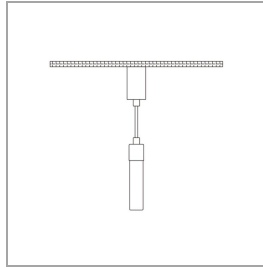

Vertical pendant suspended mounting (LN360-11)

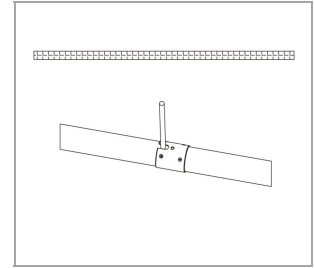

Metal joiner for side cable entry end cap (LN360-12)

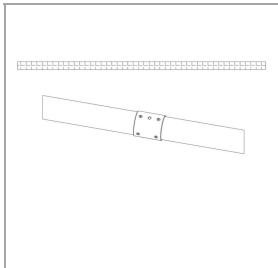

Metal joiner for closed end cap (LN360-13)

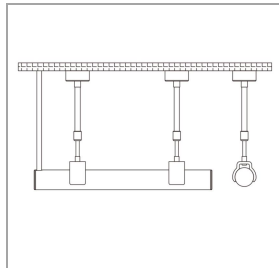

Telescoping mounting with clear open clip (LN360-14)

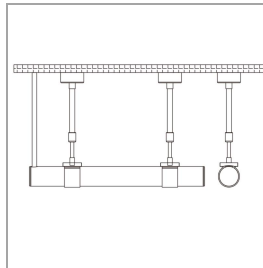

Telescoping mounting with closed PC clips (LN360-15)

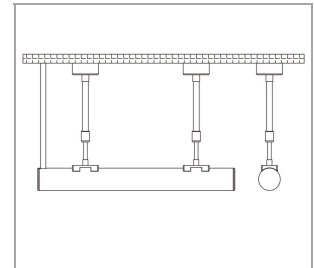

Telescoping mounting with thin clips (LN360-16)

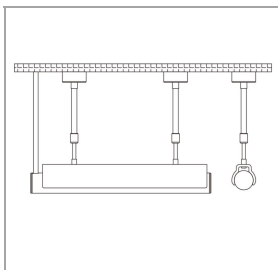

Telescoping mounting with PC profile (LN360-17)

01 LINIO NEON 360° – Surface mounting with open PC clips (LN360-01)

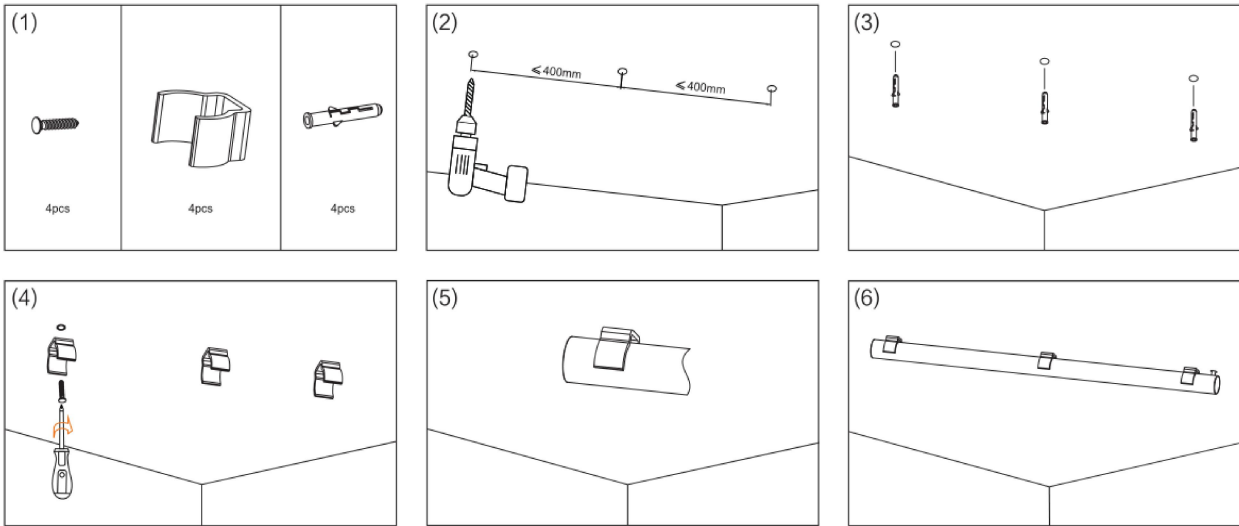

02 LINIO NEON 360° – Surface mounting with closed clips (LN360-02)

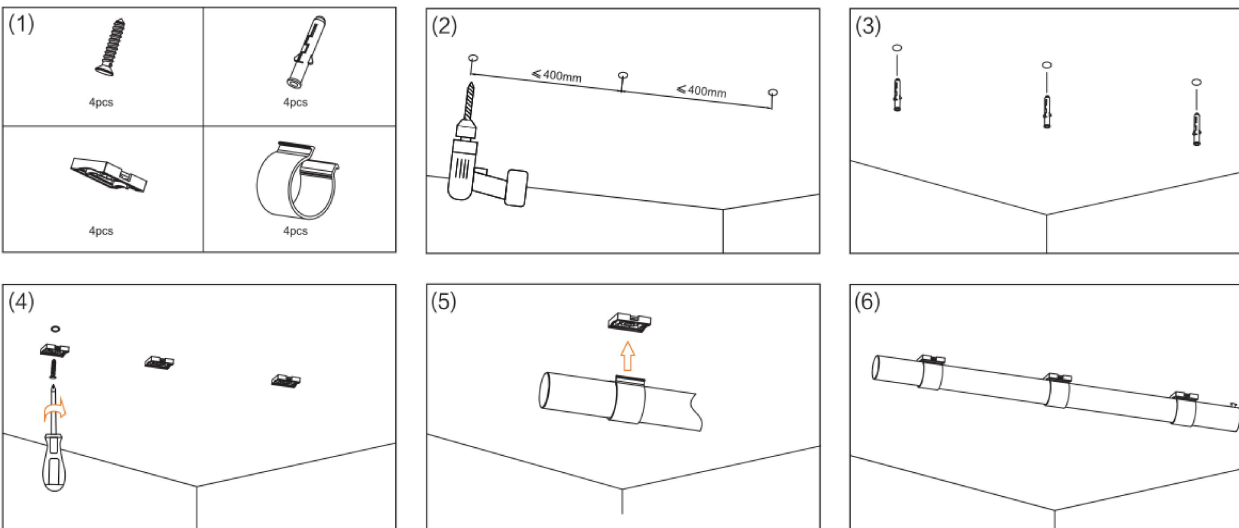

LINIO NEON 360° RGBW

Installation Instructions



03 LINIO NEON 360° – Surface mounting with clear low profile clip(LN360-03)

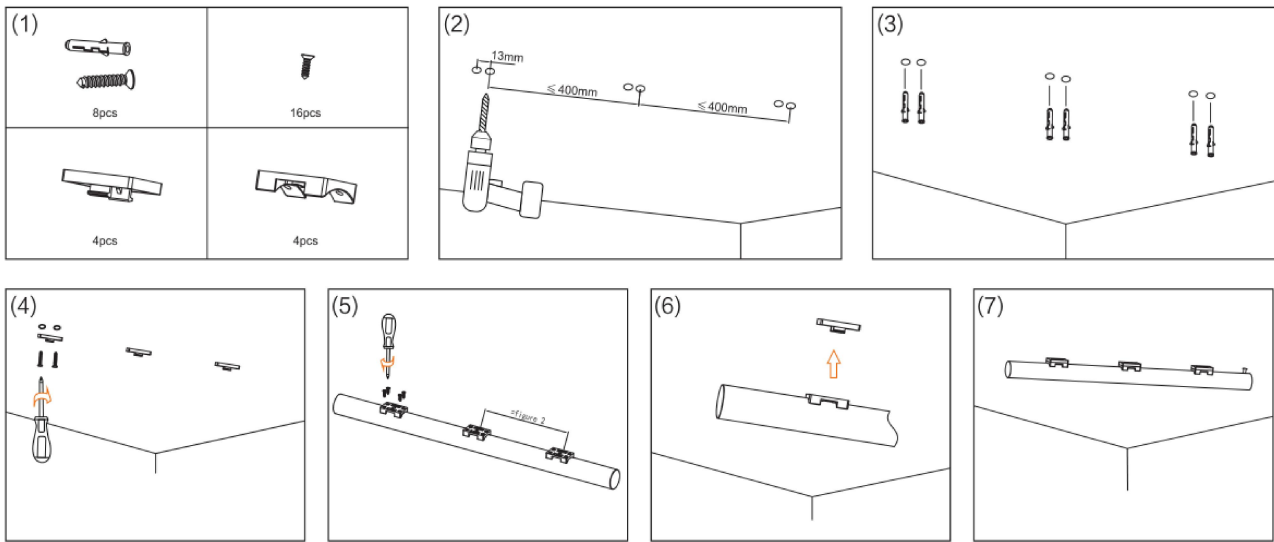

04 LINIO NEON 360° – Surface mounting with PC profile (LN360-04)

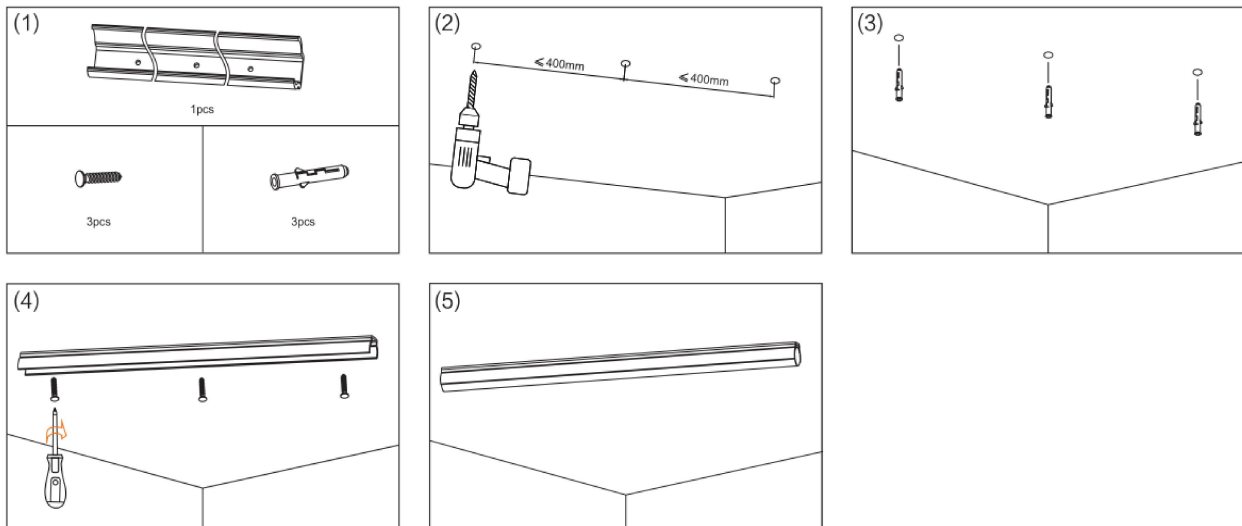

05 LINIO NEON 360° –Suspended mounting with open PC clips (LN360-05)

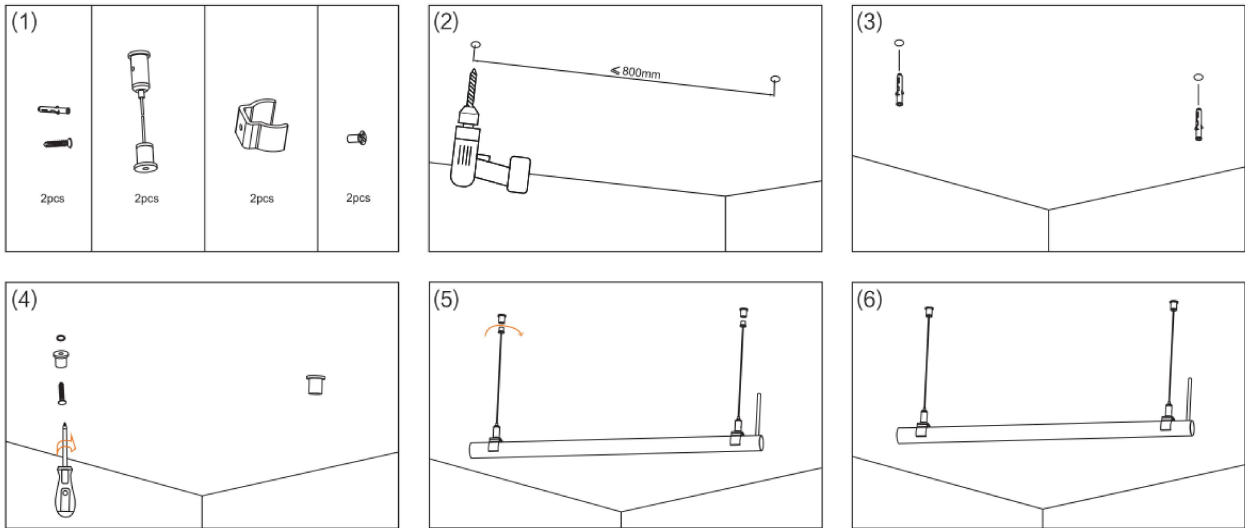

06 LINIO NEON 360° – Suspended mounting with clear closed clip(LN360-06)

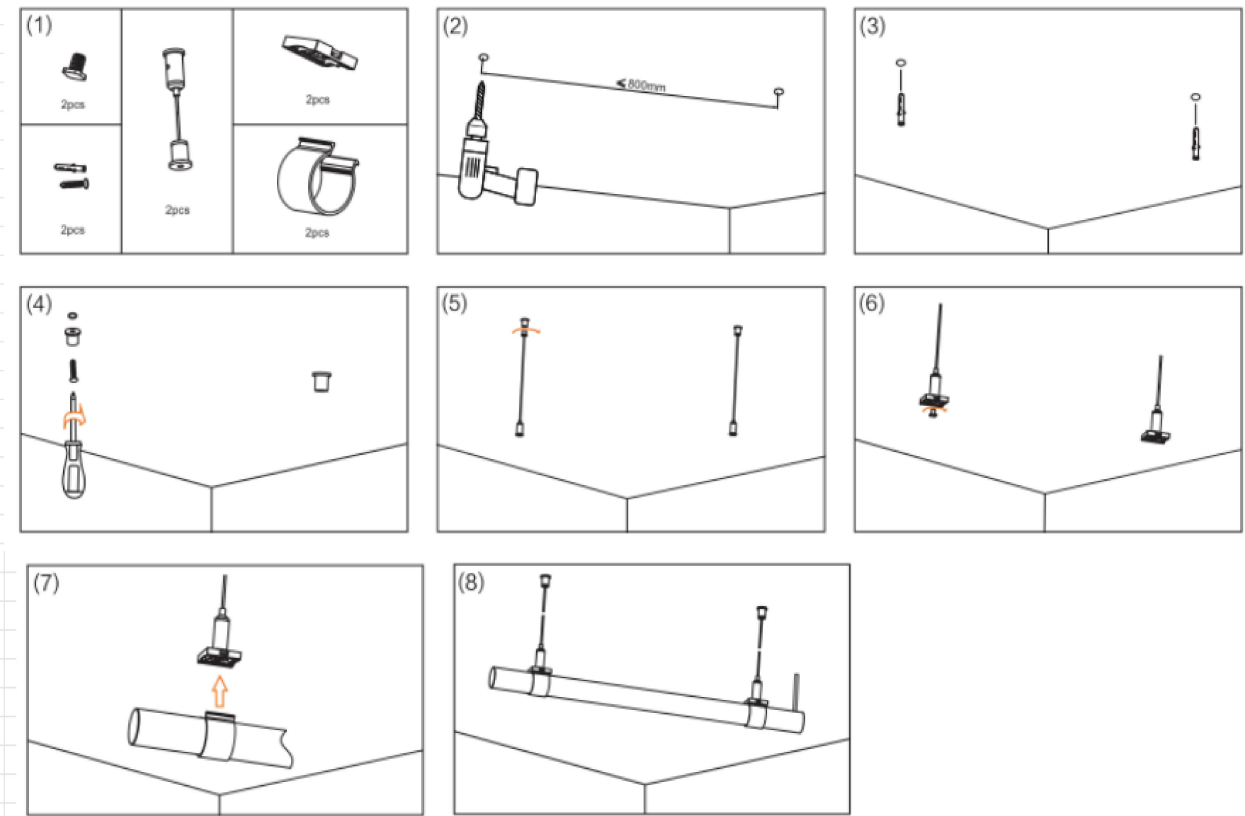

LINIO NEON 360° RGBW

Installation Instructions



07 LINIO NEON 360° – Suspended mounting with clear low pprofile clip(LN360-07)

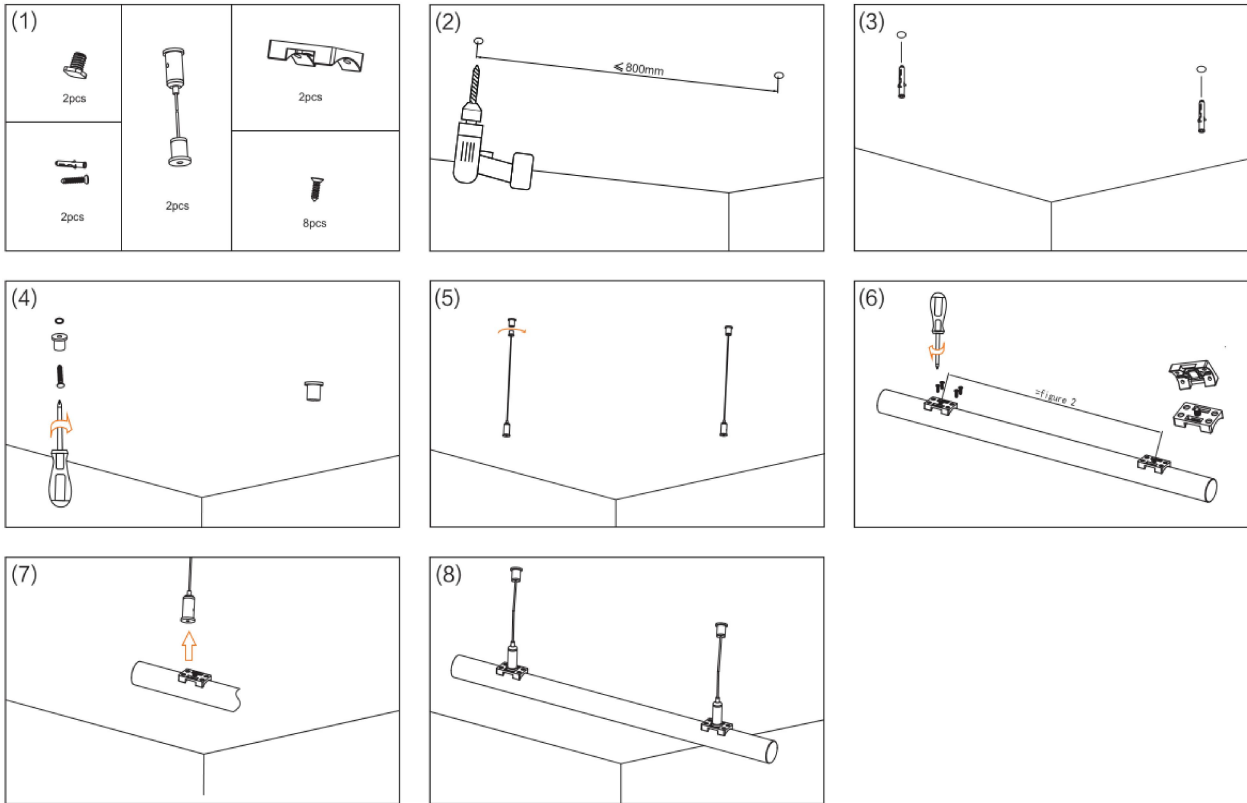

08 LINIO NEON 360° – Horizontal suspended mount with PC profile (LN360-08)

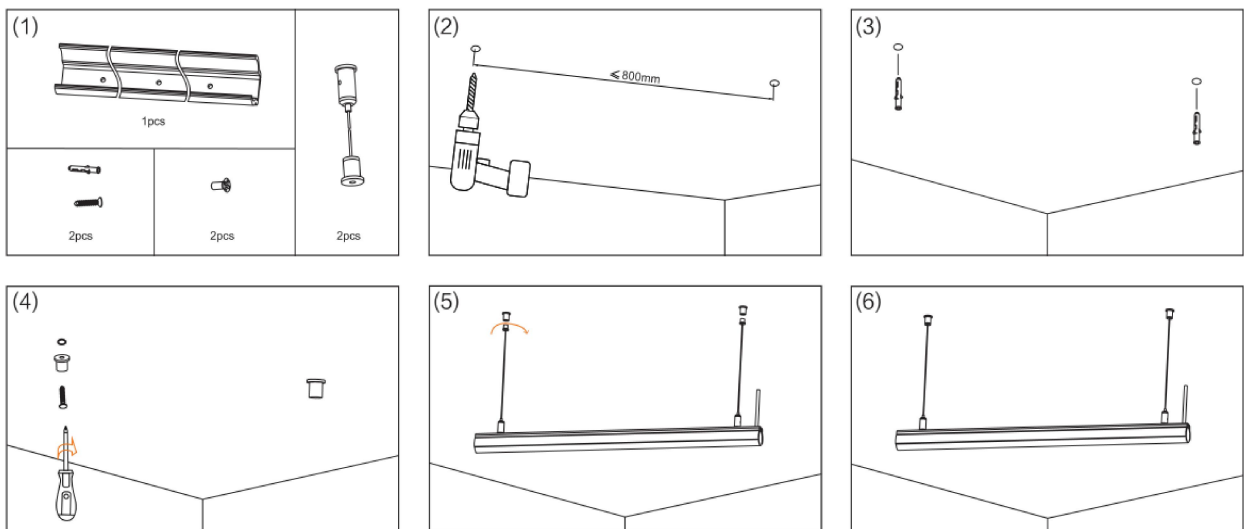

LINIO NEON 360° RGBW

Installation Instructions



09 LINIO NEON 360° – Vertical metal flush mounting (LN360-09)

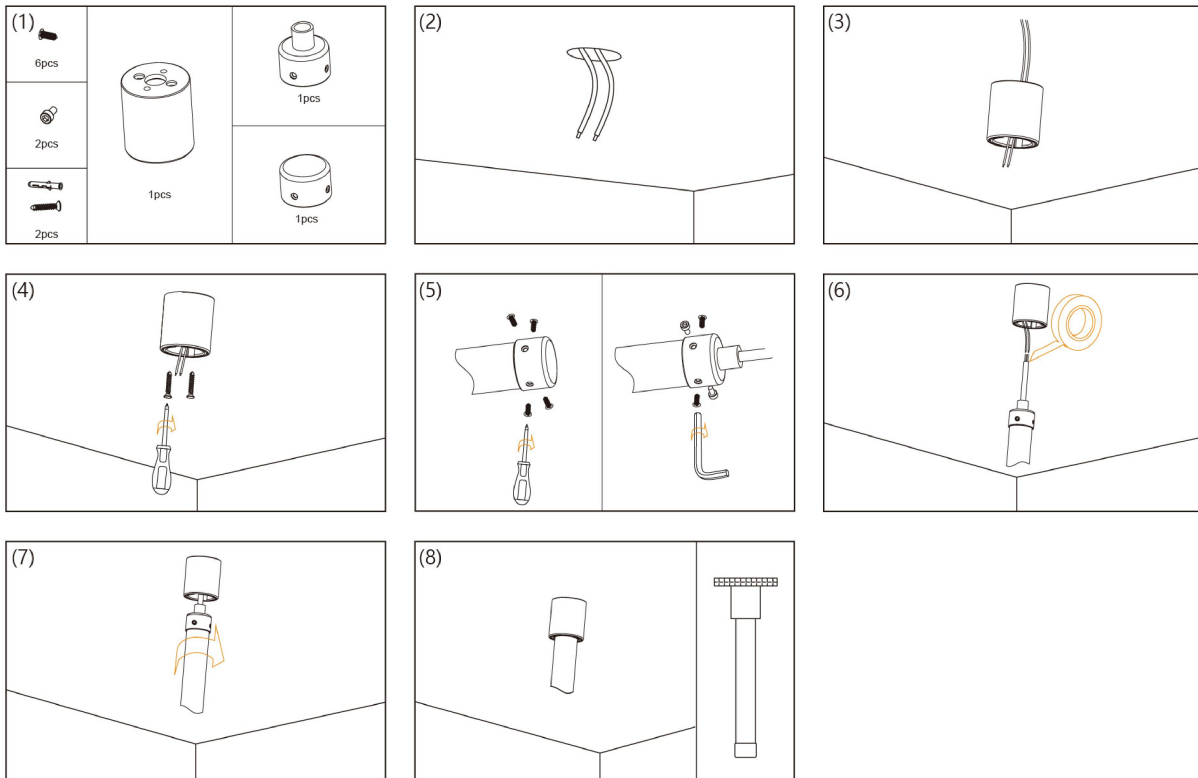

LINIO NEON 360° RGBW

Installation Instructions



10 LINIO NEON 360° – Metal flush mounting for “U” shape (LN360-10)

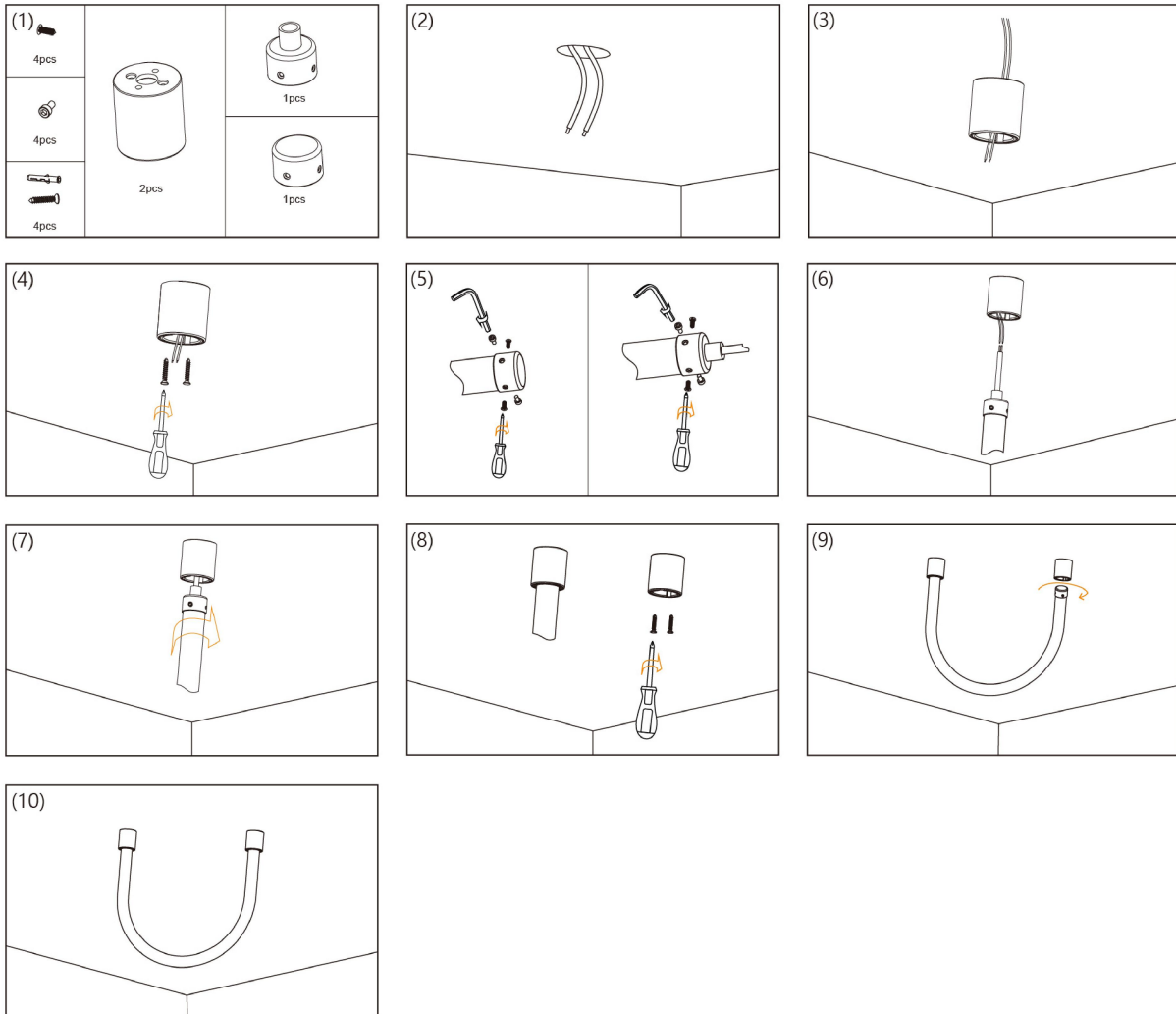

11 LINIO NEON 360° – Vertical pendant suspended mounting (LN360-11)

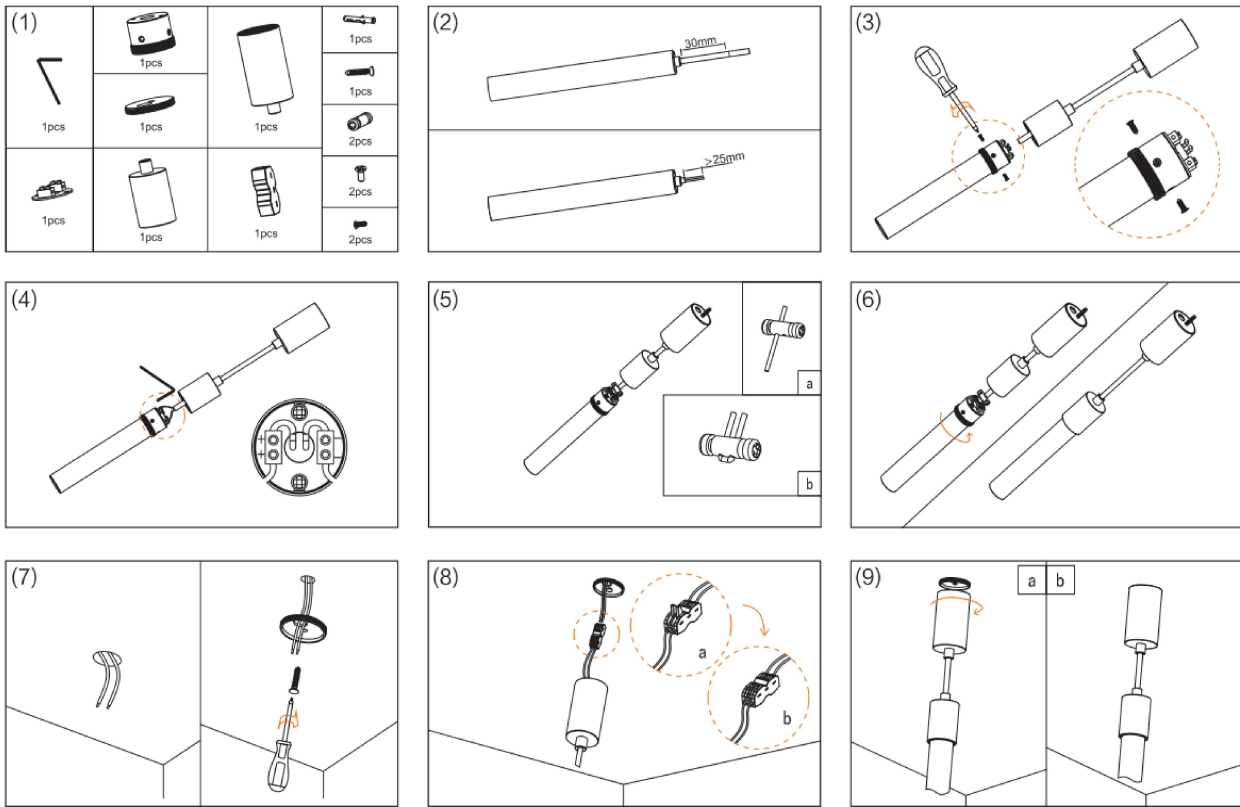

12 LINIO NEON 360° – Metal joiner for side cable entry end cap (LN360-12)

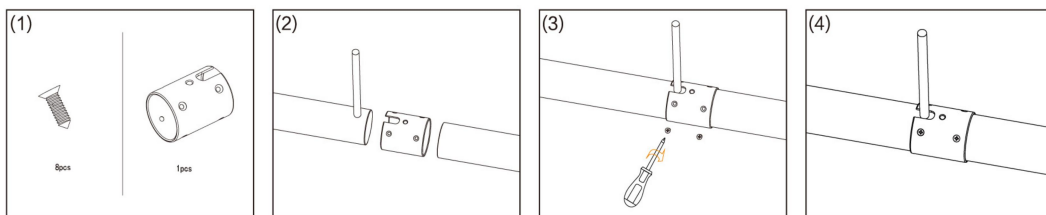

13 LINIO NEON 360° – Metal joiner for closed end cap (LN360-13)

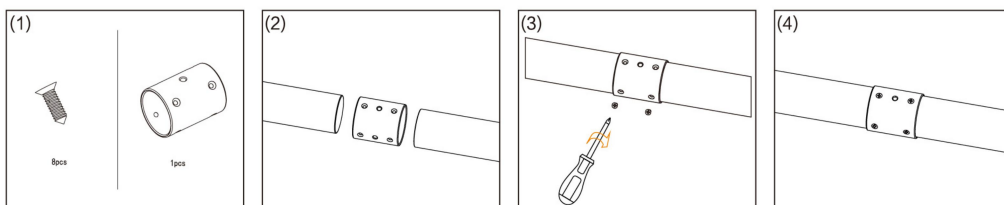

LINIO NEON 360° RGBW

Installation Instructions



14 LINIO NEON 360° – Telescoping mounting with clear open clip(LN360-14)

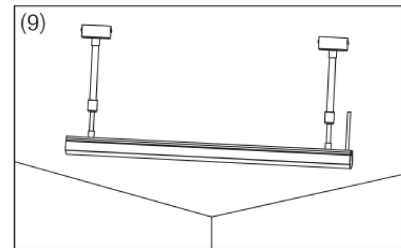
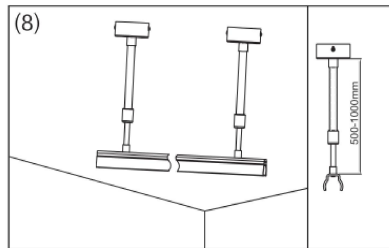
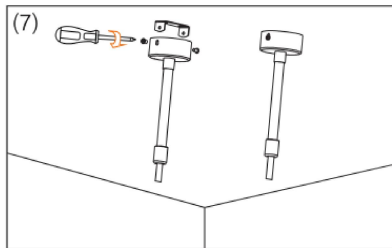
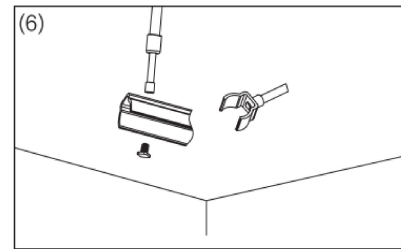
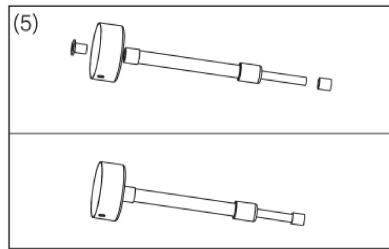
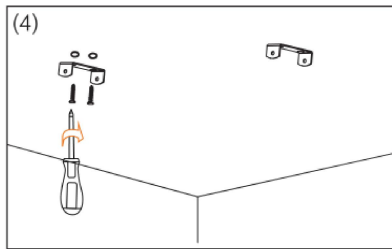
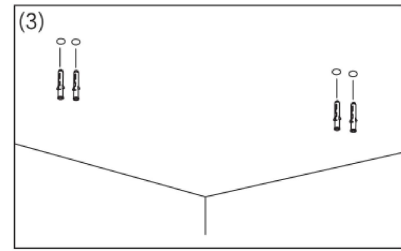
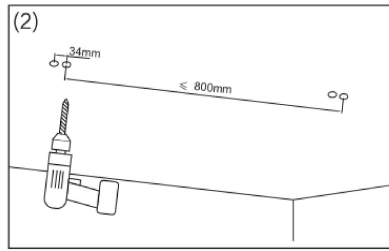
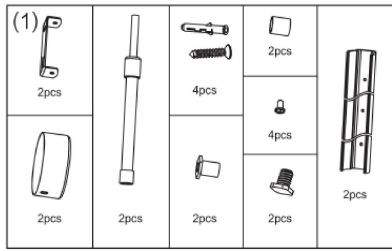

LINIO NEON 360° RGBW

Installation Instructions



15 LINIO NEON 360° – Telescoping mounting with closed PC clips (LN360-15)

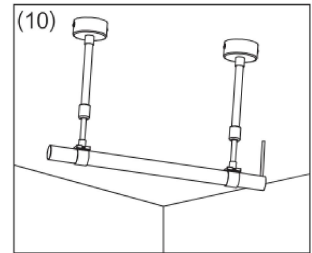
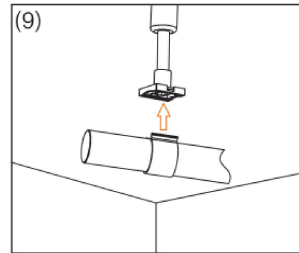
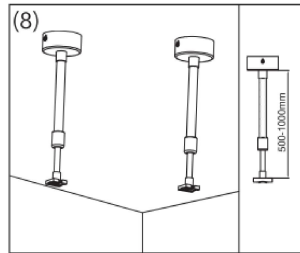
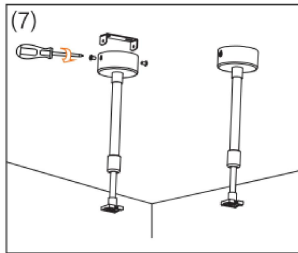
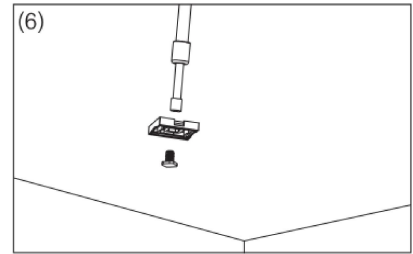
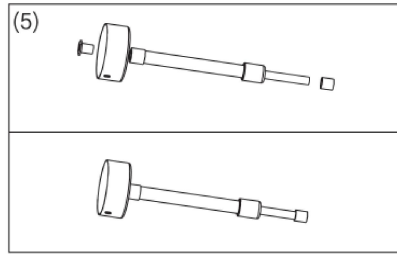
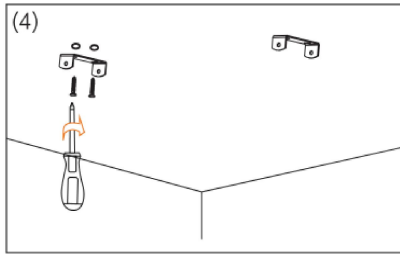
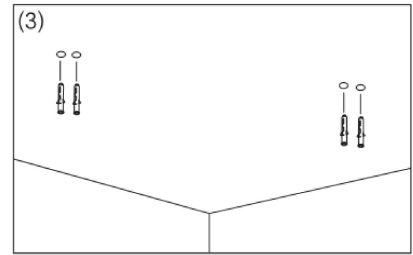
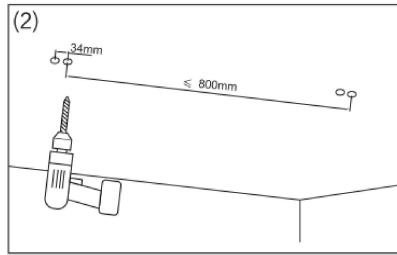
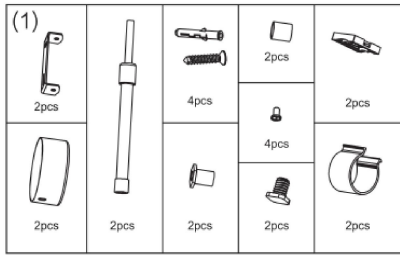

LINIO NEON 360° RGBW

Installation Instructions



16 LINIO NEON 360° – Telescoping mounting with low profile clips (LN360-16)

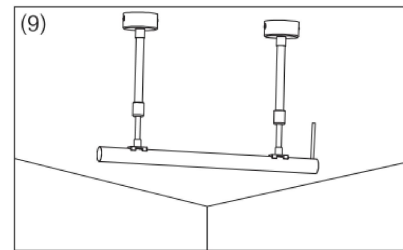
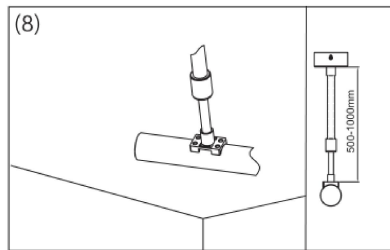
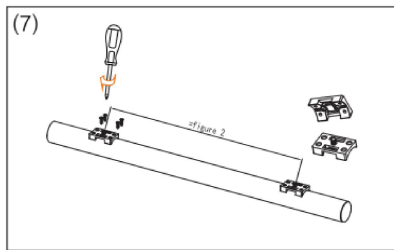
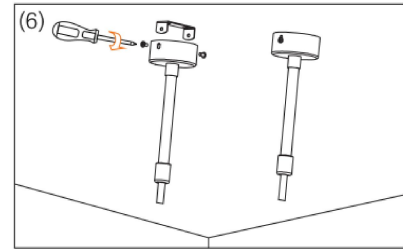
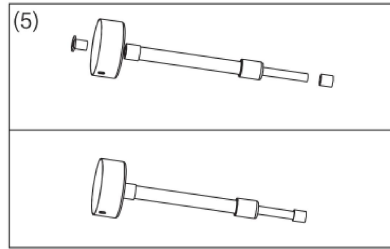
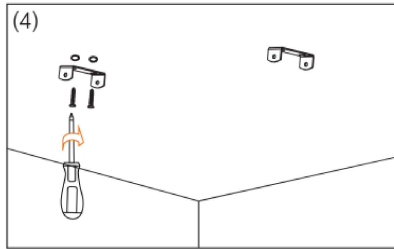
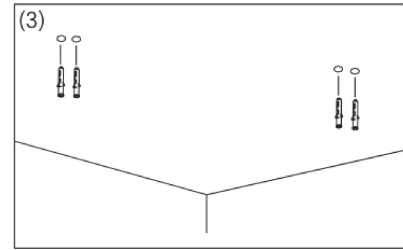
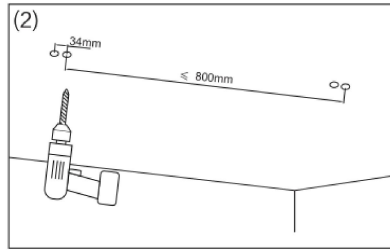
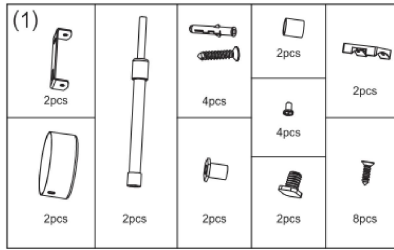

LINIO NEON 360° RGBW

Installation Instructions



17 LINIO NEON 360° – Telescoping mounting with PC profile (LN360-17)

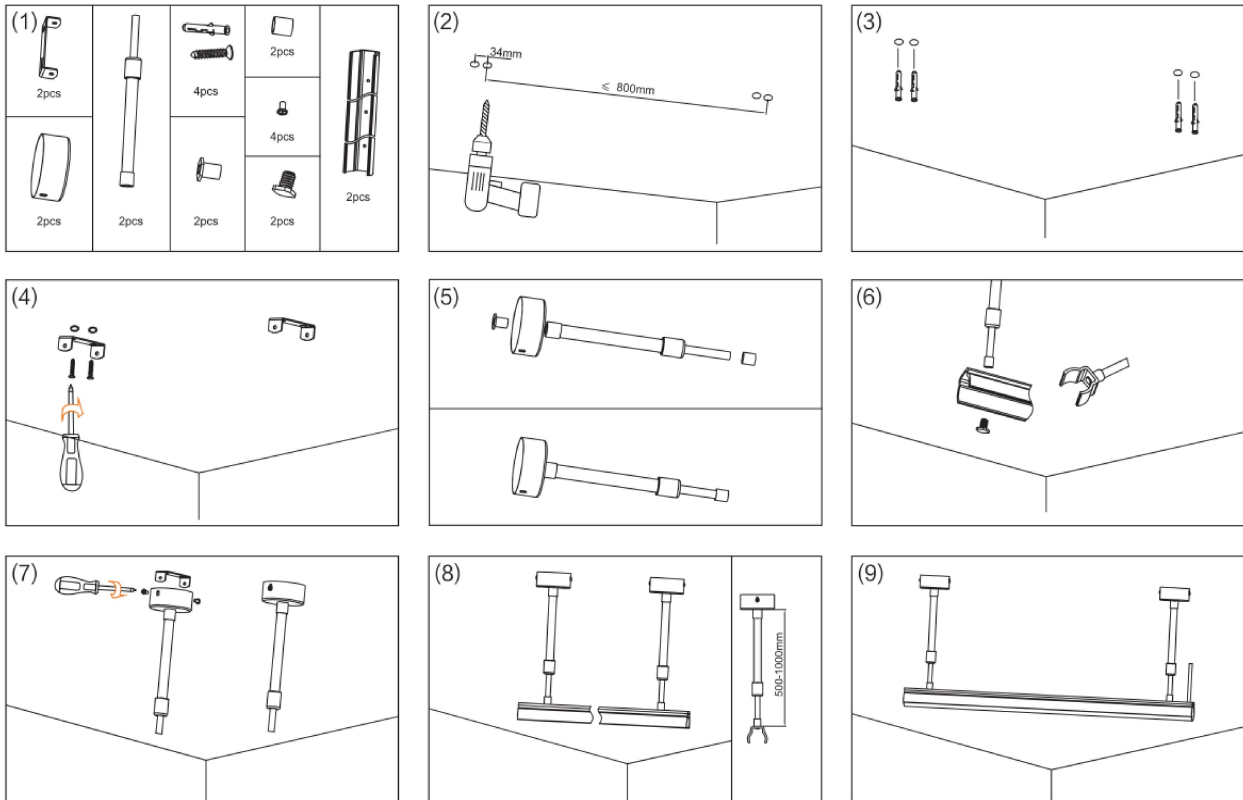

Wiring Diagram

- Note**
- Disconnect power at the source prior to attempting installation.
 - Use this product with appropriate 24V DC power supply only. Any other power supply may damage the product.
 - Always observe proper polarity.
 - Ensure to add 20% buffer when sizing power supply.
 - Ensure that the power cable carried current is no greater than 80% of its capacity.
 - To minimize the voltage drop and keep light consistency, position power supply nearest to the power feed end of the fixture and keep the power line as short as possible.
 - Prior to installing 24V DC power supply, refer to the power supply installation instruction for more information.

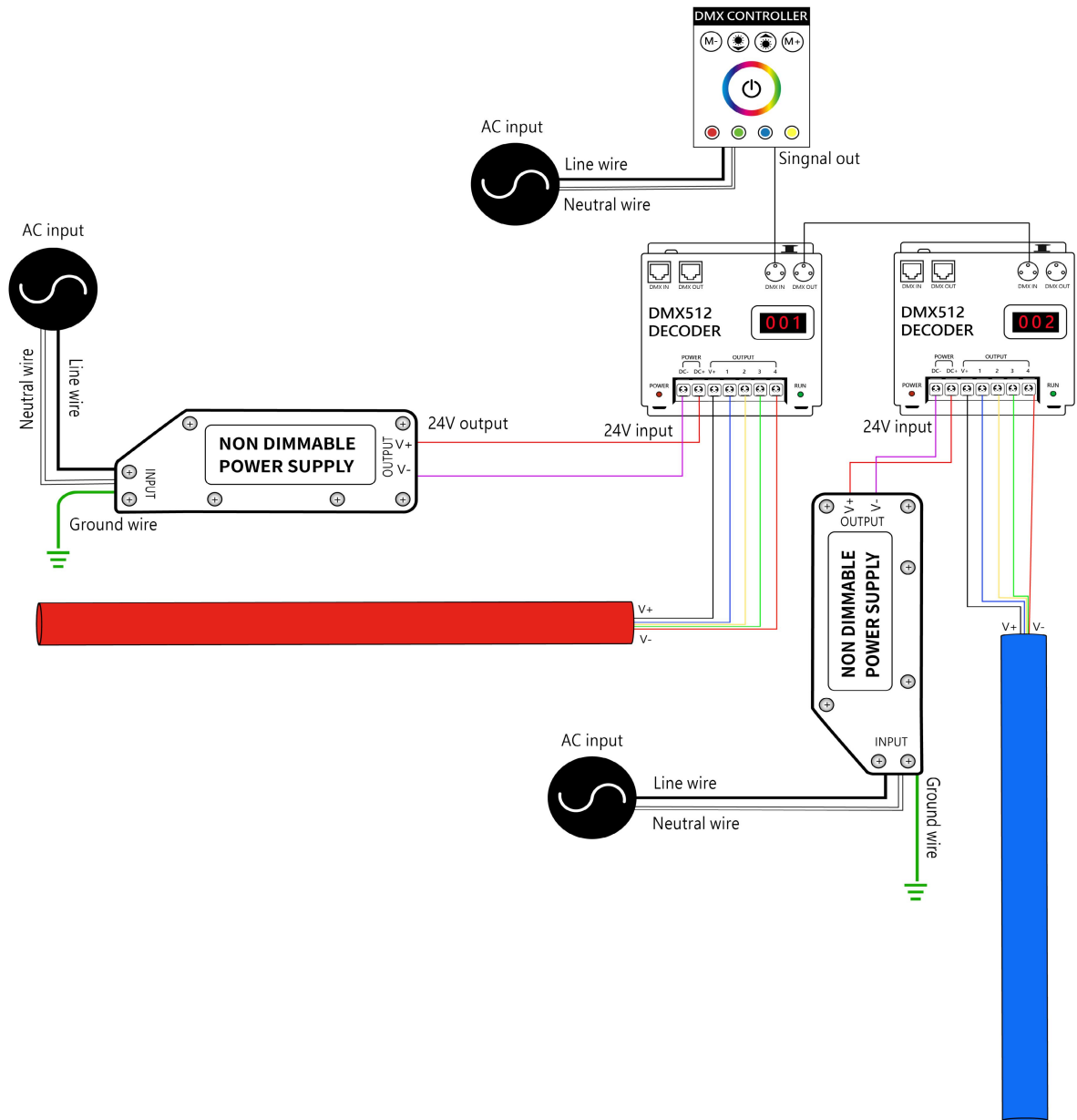

Trouble Shooting

01 The whole fixture doesn't work.

- Check whether the power supply is plugged in, switched on and receiving power.
- Check whether the fixture, decoders, controllers are connected to the power supply correctly.
- Check whether the polarity of all wire connections are connectd correctly.
- Make sure power supply output voltage is 24V DC.
- Check whether the connector and end caps are inserted behind the PCB properly.

02 Light emitting appear dim or dull at one end.

- Check whether the output voltage of the power supply is lower than that of the fixture.
- Adjust the dimming level to the maximum.
- Try to power the fixture from both ends or shorten lighting length to prevent voltage drop.
- Check whether the fixture is too far away from the power supply leading to voltage drop.

03 Light emitting appear excessive brightness.

- Check whether the output voltage of power supply is higher than that of the fixture.
- Check whether the power grid is stable.

04 The first segment of the fixture doesn't work.

- Check whether the fixture is NOT cut on indicated cutting mark in a straight line.
- Cut out and remove the first segment.
- Check whether the first LED is damage when inserting the cable connector/end cap. Cut out and remove the first segment and properly assemble again.
- Check whether there is water ingress due to poor connector/end cap assembling, leading to short circuit of first segment. Replace the length with a new one.
- Check whether there is external impact damage inside LEDs. Replace the length with a new one.

05 Fixture is flashing on and off.

- Check whether the sizing of the power supply supports the length of the fixture.
- Select the appropriate strength or install additional power supply.
- Check whether power supply output voltage is stable.
- Check whether the connector/end cap is properly installed with good contact with the copper PCB.
- Check whether proper controller is connected for light working.