

LINIO NEON 1220 SV BLACK

Outdoor · Horizontal Bending · Black Body

Beamever

Features

- Field cuttable & joinable
- Black color body finish
- Low voltage 24V DC
- UV stable without yellowing or cracking over time
- IP67 rated, ideal for indoor and outdoor uses
- 5 years warranty



| | |
|---------------|--|
| Fixture type | |
| Project name | |
| Project phase | |
| Date | |

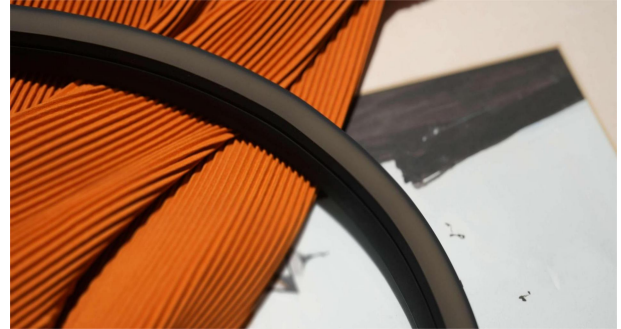

Dimension & Bending

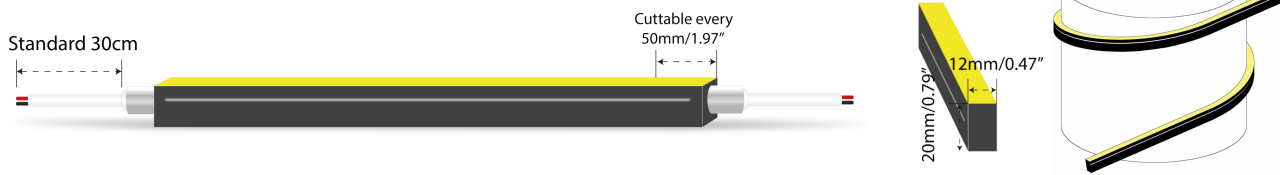

Physical

| | |
|------------------------|--|
| Dimensions | 12mm x 20mm (width x height) |
| Bend Direction | Horizontal bending |
| Bend Diameter | 150mm |
| Cutting Interval | 50mm |
| Field Cuttable | Yes |
| Housing Material | Dow Corning |
| Housing Technique | Co-extrusion |
| Body Color | Black |
| Finish | Matte |
| Feed Entry | Front, side, bottom |
| Feed Length | Standard length 30cm |
| End Cap | Injected (Factory made only) |
| Mounting | Clips or channel (rigid or bendable) |
| Storage Temperature | -25~60°C (-13~140°F) |
| Ambient Temperature | Ta _{min} = -25°C/-13°F, Ta _{max} (See below) |
| Max. Production Length | 30m |

Performance & Electrical

| | |
|-------------------|-------------------------------|
| Voltage | 24VDC (23.5Vmin, 24.5Vmax) |
| Beam Angle | 120° |
| MacAdam | 2 steps |
| Efficacy (lm/W) | 10lm/w@4000K 5W, |
| CRI | >90 |
| Lumen Maintenance | > 54,000 hours |
| IP Rating | IP67 |
| Resistance | UV, solvent, saltwater, flame |
| Dimming | PWM, 0-10V, DMX |
| Warranty | 5 years |

Certification & Safety

| | |
|----------------|----------------------------|
| Certifications | UL, CE, REACH, RoHS, CB |
| Environment | Dry, damp or wet locations |

| Lumen/m | 5W | 10W | 15W |
|--|------------|------------|-----------|
| ■ 2700K | 47 | 90 | 136 |
| ■ 3000K | 53 | 105 | 158 |
| ■ 3500K | 52.5 | 105 | 157.6 |
| ■ 4000K | 53.5 | 106 | 160 |
| Max. Run Length (m) | 27 | 17 | 14 |
| Max. Run for Mechanical End Cap (m) | 20 | 10 | 6.6 |
| Ambient Temperature (Ta _{max}) | 55°C/131°F | 45°C/113°F | 35°C/95°F |

LINIO NEON 1220 SV BLACK

Outdoor · Horizontal Bending · Black Body



Order Code

| Series | Temp./Color | Power | Feed Entry | Connector Wire | End Cap | Length(mm) |
|-----------|--|------------------------------|--|---|---|--|
| LN1220SVB | 27=2700K 30=3000K 35=3500K 40=4000K | 005=5W 010=10W 015=15W | FF=Front + Front BB=Bottom + Bottom SS=Side + Side FC=Front + Closed FB=Front + Bottom BF=Bottom+Front FLS=Front + Left Side FRS=Front + Right Side BC=Bottom + Closed BLS=Bottom + Left Side BRS=Bottom + Right Side LSC=Left Side + Closed RSC=Right Side + Closed | OW=Open wire 30cm MFCB=Male & female connector with 30cm black cable | IJ=Injected end cap (IP67) MEC=Mechanical end cap (IP67) * End caps are added by default * MEC will reduce max. run length, consult Beamever for specific data | Min. - 50mm Max. run - 27000mm@5W - 17000mm@10W - 14000mm@15W Cut Inc. - 50mm |

Example: LN1220SVB-27-305-FF-OW-IJ-05000

* Customizable—Contact Beamever representatives

Feed Entry Options

For injected end cap (IP67), factory made only

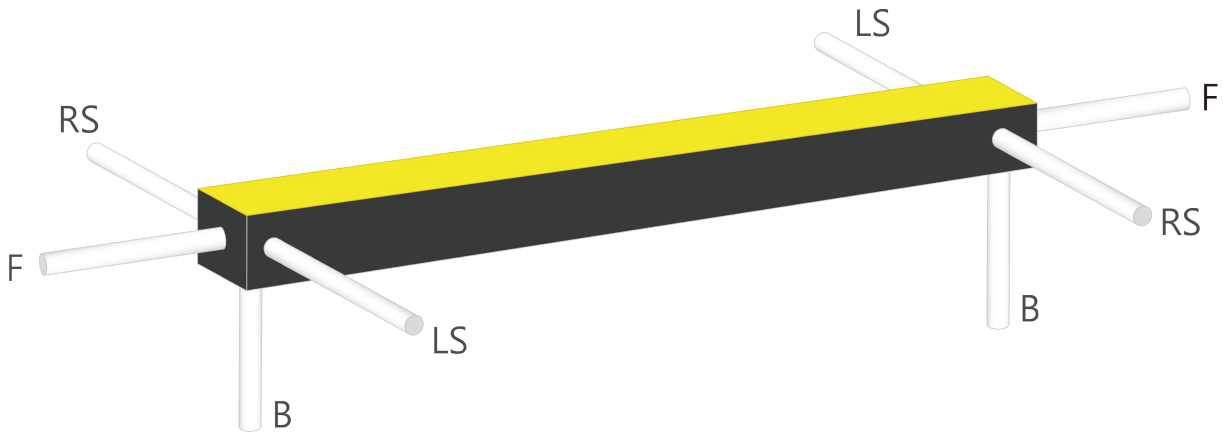

LINIO NEON 1220 SV BLACK

Outdoor · Horizontal Bending · Black Body

Beamever

Mounting Options

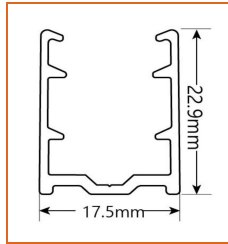

* Standard length is 1m/pcs.

| | |
|----------------|---------------------------|
| Name | Straight Aluminum channel |
| Code | LN1220B-SC |
| Material | Aluminum |
| Mounting style | Surface mounted |
| Length | 1m |
| Width | 17.5mm |
| Height | 22.9mm |
| Internal width | / |

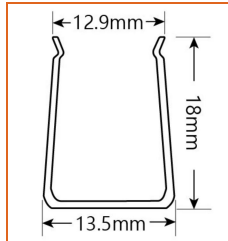
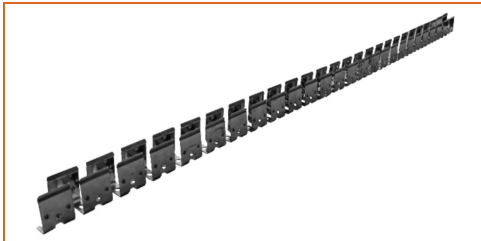

* Standard length is 1m/pcs.

| | |
|----------------|------------------|
| Name | Bendable channel |
| Code | LN1220-BC-B |
| Material | Stainless Steel |
| Mounting style | Surface mounted |
| Length | 1m |
| Width | 13.5mm |
| Height | 18mm |
| Internal Width | 12.9mm |

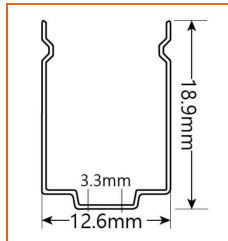

* Recommend use 4 mounting clips for 1m of neon.

| | |
|----------------|-----------------|
| Name | Mounting clip |
| Code | LN1220B-CL |
| Material | Stainless Steel |
| Mounting style | Surface mounted |
| Length | 20mm |
| Width | 12.6mm |
| Height | 18.9mm |
| Internal Width | / |

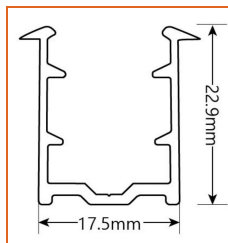

* Standard length is 1m/pcs.

| | |
|----------------|---------------------------|
| Name | Recessed straight channel |
| Code | LN1220B-RSC |
| Material | Aluminum |
| Mounting style | Recessed mounted |
| Length | 1m |
| Width | 17.5mm |
| Height | 22.9mm |
| Internal width | / |

LINIO NEON 1220 SV BLACK

Outdoor · Horizontal Bending · Black Body



Driver Options

| Code | Max Load | Input | Output | Dimming | Environment | Size |
|-----------------|----------|-------------------------------|--------|-------------------------|---------------|------------------------------|
| ELG-150-24B-3Y | 150W | 100-305V | 24VDC | 3 in 1 dimming function | Dry/Damp/IP67 | 219*63*35.5mm (L x W x H) |
| ELG-150-24DA-3Y | 150W | 100-305V | 24VDC | DALI control technology | Dry/Damp/IP67 | 219*63*35.5mm (LxWxH) |
| LPV-150-24 | 150W | 180-305V | 24VDC | Non dimmable | Dry/Damp/IP67 | 148x40x30mm (L x W x H) |
| LRS-150-24 | 150W | 85-132V / 170-264V, select by | 24VDC | Non dimmable | Dry | 99x97x30mm (L x W x H) |
| XLG-150-24-A | 150W | 100-305V | 24VDC | Non dimmable | Dry/Damp/IP67 | 180*63*35.5mm (L x W x H) |
| PWM-120-24 | 120W | 90-305V / 127-431VAC | 24VDC | 3 in 1 dimming function | Dry/Damp/IP67 | 191*63*37.5mm (LxWxH) |

* Please refer to the spec sheet of each power supply for more detailed information

Accessories Options



Name Mechanical end cap (G1)

Code LN1220-MEC1-C

Mechanical closed end cap with screws (G1)

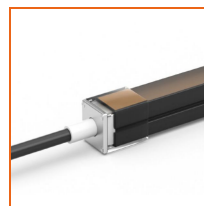

Name Mechanical end cap (G1)

Code LN1220-MEC1-F-2P

Mechanical end cap with screws (G1), front entry with 30cm black cable, 2 pin



Name Mechanical end cap (G1)

Code LN1220-MEC1-LS-2P

Mechanical end cap with screws (G1), left side entry with 30cm black cable, 2 pin



Name Mechanical end cap (G1)

Code LN1220-MEC1-RS-2P

Mechanical end cap with screws (G1), right side entry with 30cm black cable, 2 pin



Name Mechanical end cap (G1)

Code LN1220-MEC1-B-2P

Mechanical end cap with screws (G1), bottom entry with 30cm black cable, 2 pin



Name Male and female connectors

Code MFC-2P-67-B

Male and female connectors with 30cm black cable, 2 pin



Name Extension connectors

Code ETC-2P-67-1M

Extension Male and female connectors with 3.28ft black cable, 2 pin



Name Extension connectors

Code ETC-2P-67-5M

Extension Male and female connectors with 16.4ft black cable, 2 pin

LINIO NEON 1220 SV BLACK

Outdoor · Horizontal Bending · Black Body

Beamever

Wiring Diagram

Non Dimmable

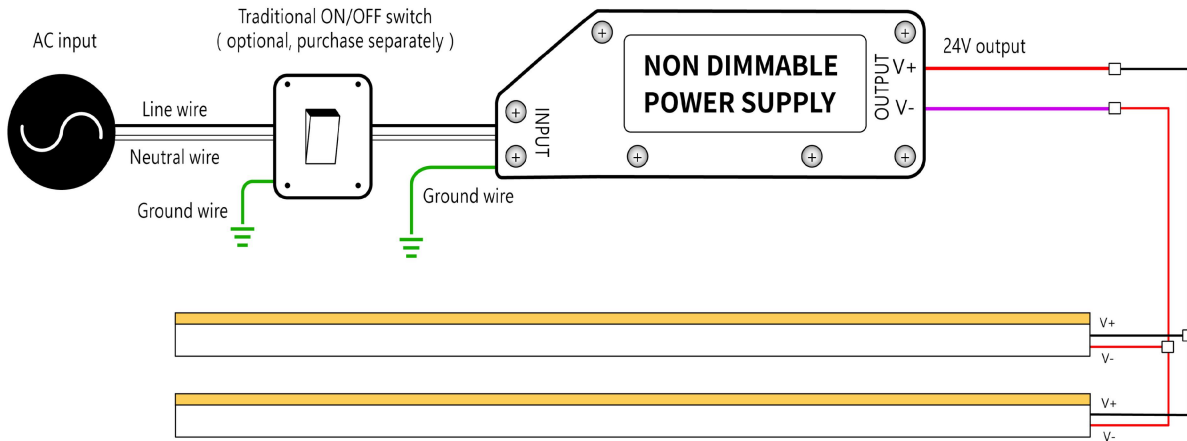

Dimmable

